

ME231

Three-phase multifunctional smart meter V1.4



ROGOWSKI TECHNOLOGY (SHANGHAI) CO., LTD.

Contents

1 Product description	1
1.1 ME231 Model naming Rules	1
2 Data display	2
3 Accuracy and certification	4
4 Connection	4
4.1 Power supply	6
4.2 Voltage and current input	6
4.3 RS485	8
4.4 Relay output	8
4.5 Digital input	8
5 Operation and interface display	8
5.1 Key function display description	9
5.2 Meter start interface	9
5.3 Meter display mode switching	9
5.4 Measure menu interface	10
5.4.1 Measure menu-Instantaneous value interface	11
5.4.2 Measure menu-Energy interface	12
5.4.3 Measure menu-Harmonics interface	13
5.4.4 Measure menu- Phasor diagram interface	14
5.4.5 Measure menu- Demand interface	15
5.4.6 Measure menu- Unbalance interface	15
5.4.7 Measure menu- Max.&Min. interface	16
5.5. Settings menu interface	17
5.4.8 Settings menu -Power Grid interface	18
5.4.9 Settings menu -Current sensor interface	18
5.4.10 Settings menu -Tariff interface	19
5.4.11 Settings menu -Demand interface	21
5.4.12 Settings menu -Communication interface	22
5.4.13 Settings menu -HMI interface	23
5.4.14 Settings menu -Password interface	23
5.5 Reset menu interface	25
5.6 Device information menu interface	26
6 Modbus Communication	27
6.1 Modbus Communication settings	27
6.2 Modbus-RTU data frame	27
6.3 PDU Request data Format	27
6.3.1 Function code	27
6.3.2 Register list	28
6.3.3 Data type list	28
6.3.4 Configure the device via the Modbus-RTU	29
6.4 Modbus-RTU Function code	29

6.4.1 Function code (0x10=16) Operation Instructions	29
6.4.2 Function code (0x03=3) operation instructions	31
6.4.3 Error response	32
6.5 List of configuration instructions	33
6.5.1 System parameter setting	33
6.5.2 Parameter setting of L1,L2,L3 current transformer	33
6.5.3 Parameter setting of N-phase current transformer	34
6.5.4 Zero drift suppression setting	34
6.5.5 Demand parameter setting	34
6.5.6 Tariff mode setting	35
6.5.7 Manual tariff setting	35
6.5.8 RTC tariff period setting	35
6.5.9 RTC tariff select setting	35
6.5.10 Device time setting:	36
6.5.11 Communication parameter setting	36
6.5.12 Reset setting	37
6.5.13 Relay output control mode	37
6.5.14 Relay output manual control	37
6.5.15 Alarm setting	37
6.6 Register list	39
6.7 Modbus Register list	40
6.7.1 Equipment parameters:	40
6.7.2 Communication parameter:	40
6.7.3 Relay	41
6.7.4 Digital input	41
6.7.5 Voltage and current phase sequence:	41
6.7.6 Configure instruction register	41
6.7.7 Power system	42
6.7.8 Zero drift suppression parameter	43
6.7.9 Tariff parameter	44
6.7.10 Voltage, current, power, power factor	45
6.7.11 Energy	46
6.7.12 Tariff Energy	48
6.7.13 Demand register	49
6.7.14 Voltage and current harmonic register	51
6.7.15 Max.&Min.	53
6.7.16 Unbalance	55
6.7.17 Current K-factor and crest factor register	55
6.7.18 Voltage and current angle register	56
6.7.19 Alarm	56
7 Revision History	64

1 Product description

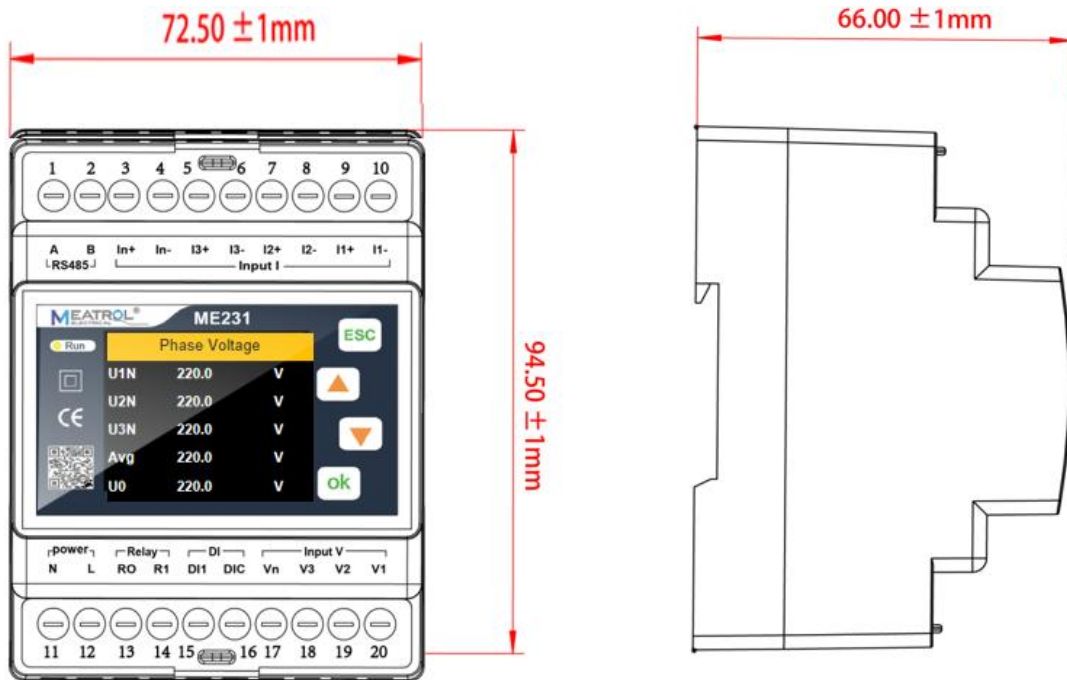

(Dimensional Drawing)

1.1 ME231 Model naming Rules

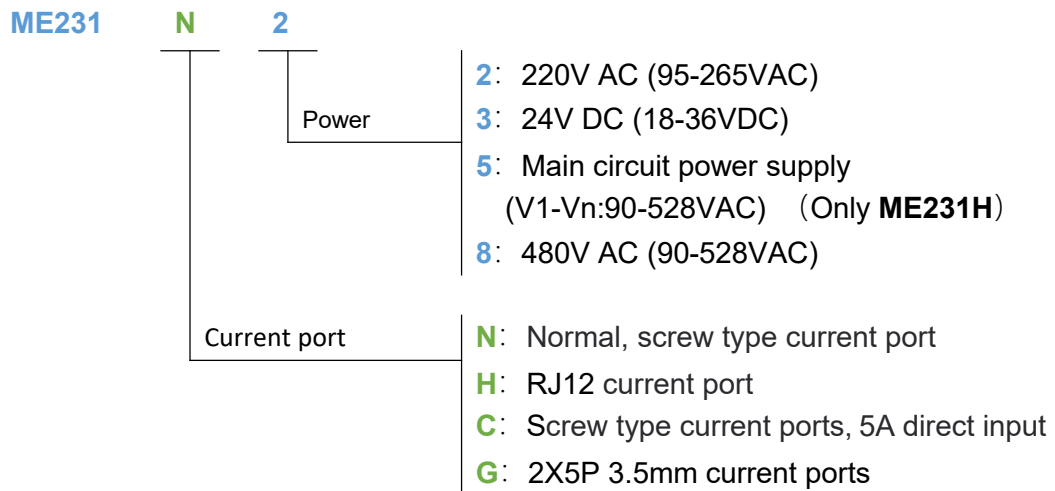

The ME231 is a DIN-Rail three-phase multifunctional smart meter that supports externally connected with open type Rogowski coil or voltage type CT, it can realize none dismantling wire test, simplify test steps, save construction cost, and is more convenient for engineering test as well as the inspection and maintenance of distribution system.

The ME231 support systems of single-phase and three-phase. It can measure multiple electrical parameters such as current, voltage, power factor, harmonics, power, energy and other electrical parameters of L1,L2,L3.The standard RS485 communication interface can be compatible with various configuration systems through the standard MODBUS-RTU protocol.

Description		
Type	DIN rail	
Model	ME231	
Current sensor type	Rogowski coil Voltage-output current clamp	
Advantage	Suitable for wide current range, no dismantling measurement	
Wiring system	3P4W 4CT, 3P4W 3CT, 3P3W 3CT, 3P3W 2CT, 1P3W, 1P2W	
Application field	Power analysis Tariff meter	
Display screen	1.77 inch TFT screen display	
Weight	259g	
Dimension	L*W*D: 9.45*7.25*6.6CM	
Color	White	
Current		
Channel input voltage range	0-900mVAC peak,636 mV RMS	
Measurement range	Different current sensors have different ranges	
Rcoil	50mV/kA@50Hz(0-12000A),@60Hz(0-10000A) 85mV/kA@50Hz(0-7000A),@60Hz(0-6000A) ...	
VCT	0~99999A	
Voltage		
Channel input voltage range	0~600VAC Phase Voltage	
Maximum range	720VAC Phase Voltage	
Digital Signal		
Relay output	One way electromagnetic relay output, contact capacity:3A 30V DC, 3A 250V AC	
Digital input	One way dry contact input, optocoupler isolation (5kVrms)	
Communication		
RS485 communication	One way RS485 communication interface Interface type: two wire half duplex Communication baudrate: 2400bps ~ 38400bps Protocol: Modbus RTU	
Power supply		
Power Supply	ME231N2	ME231N3
	95~265VAC/110~370VDC, 45~60Hz	24VDC
Maximum power consumption	3.5VA	

2 Data display

Instantaneous value

Phase Voltage	U1,U2,U3,AVG
Line Voltage	U12,U23,U31,AVG
Current	I1,I2,I3,AVG,IN
Grid Frequency	F1,F2,F3,Σ
Power Factor PF	PF1,PF2,PF3,Σ
Fundamental power factor DPF	DPF1,DPF2,DPF3,Σ
Active power	P1,P2,P3,Σ
Reactive power	Q1,Q2,Q3,Σ
Apparent power	S1,S2,S3,Σ
Energy	
Active energy Pos.	EP1,EP2,EP3,Σ
Active Energy Neg.	EP1,EP2,EP3,Σ
Reactive Energy Pos.	EQ1,EQ2,EQ3,Σ
Reactive energy Neg.	EQ1,EQ2,EQ3,Σ
Apparent Energy	ES1,ES2,ES3,Σ
Tariff Energy	ET1,ET2, ET3,ET4, ET5,ET6
Harmonics	
Voltage Harmonic Distortion	THD (Total harmonic percentage), TOHD (Odd total harmonic percentage), TEHD (Even total harmonic percentage), phase L1.L2.L3 1-50th harmonic percentage, phase ABC 1-50th harmonic voltage value
Voltage Harmonic Value	
Current Harmonic Distortion	THD (Total harmonic percentage), TOHD (Odd total harmonic percentage), TEHD (Even total harmonic percentage), phase L1.L2.L3 1- 50th harmonic percentage, phase ABC 1-50th harmonic current value
Current Harmonic Value	
Phasor diagram	
Phasor diagram	between voltage and current
Phase Sequence	voltage and current
Voltage Angle	U1,U2,U3
Current Angle	I1,I2,I3
UI Angle	UI1,UI2,UI3
Demand	
Demand	P,Q,S
Active power DMD Max.	P and Time
Reactive power DMD Max.	Q and Time
Apparent power DMD Max.	S and Time
Unbalance	
Voltage unbalance	Negative Sequence, zero Sequence
current unbalance	Negative Sequence, zero Sequence
Max.&Min.	
Phase Voltage	U1,U2,U3,AVG
Line Voltage	U12,U23,U31,AVG
Current	I1,I2,I3,AVG,IN
Active power	P1,P2,P3,Σ
Reactive power	Q1,Q2,Q3,Σ
Apparent power	S1,S2,S3,Σ

3 Accuracy and certification

Measuring accuracy	
current measurement accuracy	0.1%+Accuracy of current sensor
Voltage measurement accuracy	±0.2%(60V~600V AC)
Grid frequency	±0.01%(45~65Hz)
Power factor	±0.005
Active and apparent power	IEC62053-22 level 0.5S
Reactive power	IEC62053-21 level 1S
Active energy	IEC62053-22 level 0.5S
Reactive energy	IEC62053-21 level 1S
Environment condition	
Operating temperature	-20℃~+70℃
Storage temperature	-40℃~+85℃
Humidity range	5~95% RH, 50℃(non-condensing)
Class of pollution	2
Over voltage capability	CAT III 1000V, It is suitable for distribution system below 277 / 480VAC
Insulation strength	IEC61010-1
Altitude	3000m Max
Antipollution level	IP20 (Meet the standard of IEC 60629)
Quality guarantee period	12 months
EMC (electromagnetic compatibility)	
Electrostatic discharge	Level IV(IEC61000-4-2)
Radiated immunity	Level III (IEC61000-4-3)
EFT Electrical fast burst immunity	Level IV (IEC61000-4-4)
Surge immunity	Level IV (IEC61000-4-5)
Conducted disturbance immunity	Level III (IEC61000-4-6)
Power frequency magnetic field immunity	0.5mT (IEC61000-4-8)
Conduction and radiation	Class B (EN55022)
Measurement standard	
EN 62052-11, EN61557-12, EN 62053-21, EN 62053-22, EN 62053-23, EN 50470-1, EN 50470-3, EN 61010-1, EN 61010-2, EN 61010-031	

4 Connection

The meter is equipped with rich interfaces to realize different functions.

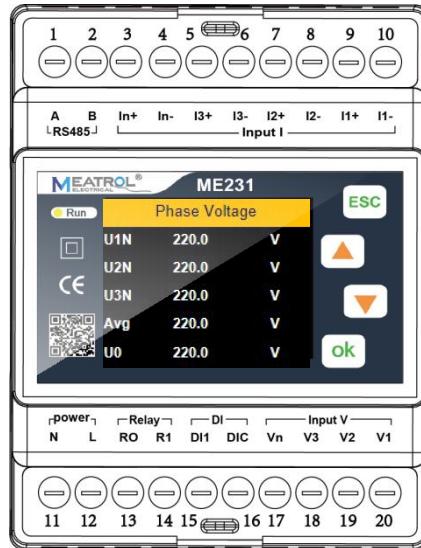

Point number	Point name	Point function	Point type	Remarks
1	A	RS485 communication A	RS485	RS485 communication
2	B	RS485 communication B		
3	In+	Phase N current input positive	Current input	Current channel
4	In-	Phase N current input negative		
5	I3+	Phase L3 current input positive		
6	I3-	Phase L3 current input negative		
7	I2+	Phase L2 current input positive		
8	I2-	Phase L2 current input negative		
9	I1+	Phase L1 current input positive		
10	I1-	Phase L1 current input negative		
11	N	Power supply (-)	Power supply	Range 95~265VAC, 45~60Hz 110~260VDC
12	L	Power supply (+)		
13	R0	Relay common contact	Relay output	One relay output with normally open
14	R1	Relay normally open contact		
15	DI1	Digital input channel 1	Digital input	ONE way dry contact input
16	DIC	Digital channel common terminal		
17	Vn	N-phase voltage input	Voltage input	Measurement voltage input channel
18	V3	L3-phase voltage input		
19	V2	L2-phase voltage input		
20	V1	L1-phase voltage input		

4.1 Power supply

The meter adopts external power supply mode, without internal direct power supply. The power supply voltage range is 95 ~ 265VAC / 110 ~ 260VDC, 45 ~ 60Hz, and the maximum power consumption is 3.5VA.

- Do not connect the meter with the cable live.
- Before connecting the power supply, make sure that the power supply voltage is within the required range, otherwise the meter can not work normally.

4.2 Voltage and current input

The ME231 supports 6 kinds of wiring methods: 3P4W_4CT, 3P4W_3CT, 3P3W_3CT, 3P3W_2CT, 1P3W, 1P2W.

Before connecting the measurement wires, please correctly configure the wiring method of the meter.

- The actual wiring mode of the meter must be consistent with that of the internal configuration of the meter.
- 3P4W_4CT requires 4 current sensors and the N phase current is measured by the sensors
- 3P4W_3CT requires 3 current sensors, the N phase current is obtained by calculation
- 3P3W_3CT requires 3 current sensors, the L2 phase current is measured by the sensors
- 3P3W_2CT requires 2 current sensors, the L2 phase current is obtained by calculation
- The phase sequence of voltage and current must follow the phase sequence of ABC, otherwise the meter will display the phase sequence error of voltage and current.
- When using the current sensor, the direction of the current arrow on the sensor must be consistent with the actual current flow direction, that is, the current arrow of the sensor points to the load end.

The ME231 connection mode of voltage and current is as follows:

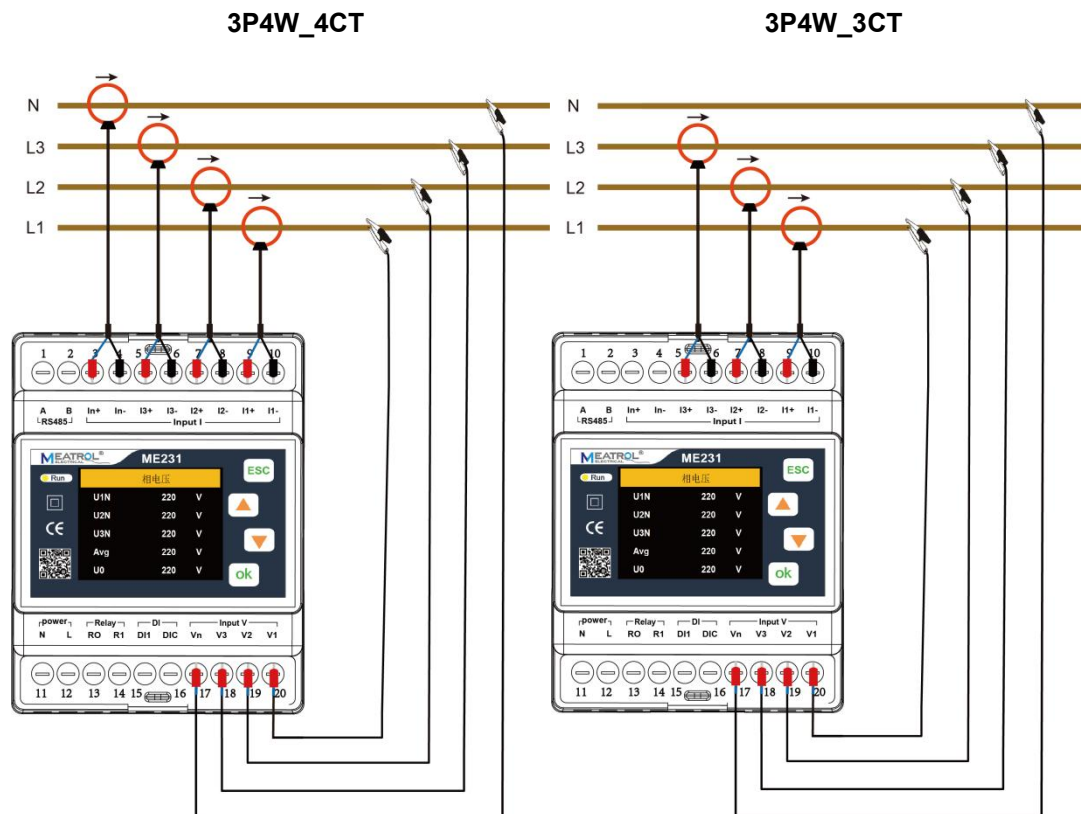

3P3W_3CT

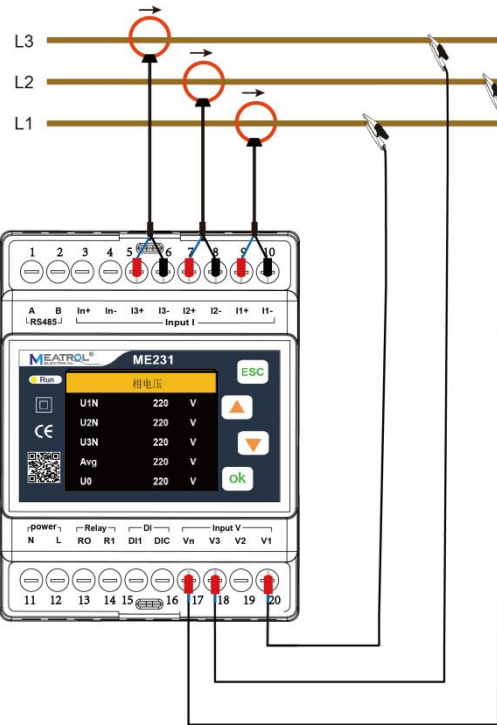

3P3W_2CT

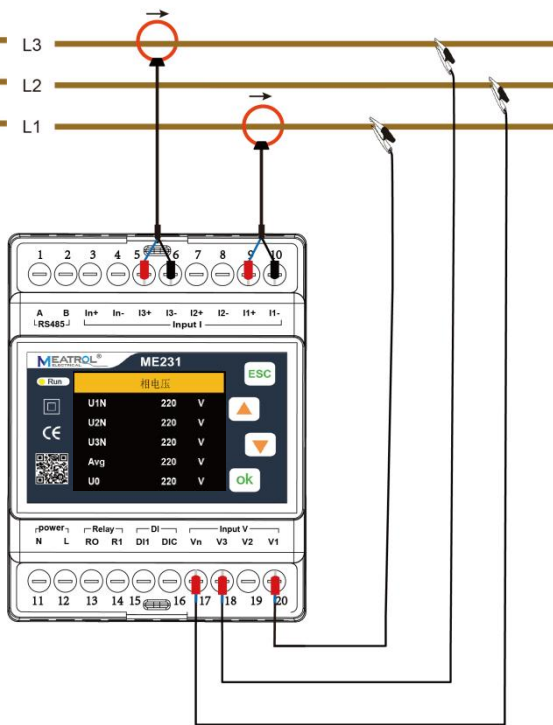

1P3W

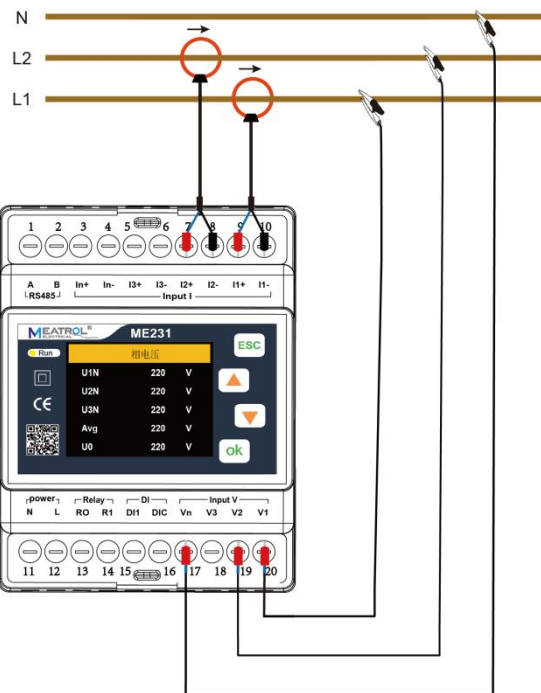

1P2W

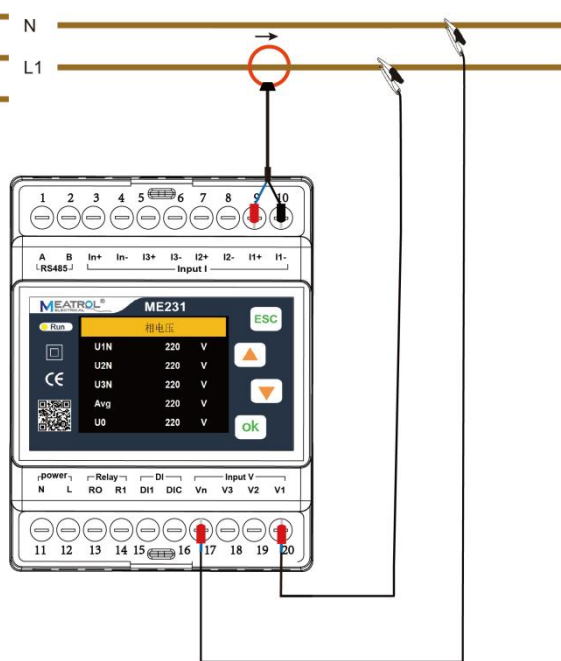

4.3 RS485

The meter is equipped with a RS485 communication interface, which supports Modbus RTU protocol. The RS485 communication port requires shielded twisted pair connection, which is connected in the form of daisy chain. In the case of long distance and high speed, a 120 Ω resistor should be parallel connected at both ends of the daisy chain.

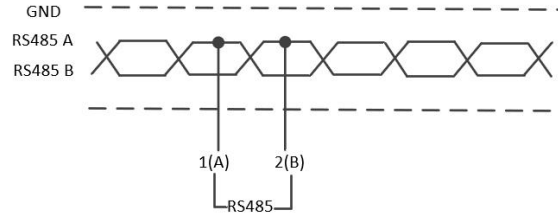

4.4 Relay output

The meter is equipped with a relay output and has one contact, normally open. The identification of terminal blocks is: R1, R0, where R0 is the common contact, R1 is the normally open contact. The relay output can be controlled by RS485 / Modbus protocol.

The closed state of normally open contact of relay is displayed on the display interface of electric meter. Maximum load capacity of relay: 3A 30V DC, 3A 250V AC

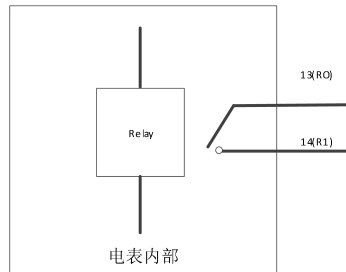

继电器输出接口连接示意图

4.5 Digital input

The meter is equipped with one digital switch inputs, which are connected by passive dry contact. The identification of terminal blocks is: DI1, DIC, where DIC is the common contact. The status of one digital switch input can be read through RS485 / Modbus protocol, and the digital switch input status can be displayed in the electric meter display interface.

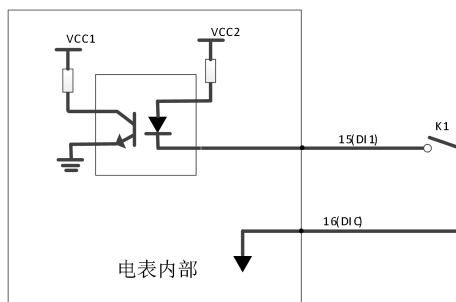

数字输入接口连接示意图

5 Operation and interface display

This section is used to describe the display of the interface and key combination operation, as well as the configuration of the equipment.

The four buttons of the meter are shown below:

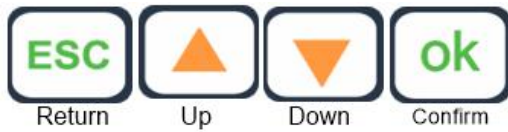

5.1 Key function display description

Key symbols	describe
	Return key: used to exit the current operation interface.
	Up key: used to switch the interface display and Long press to switch displacement,
	Down key: used to switch the interface display and Long press to switch displacement,
	Confirm key: used to confirm the operation and switch the numerical display when setting.

5.2 Meter start interface

After the meter is powered on and started, the following interface will be displayed.

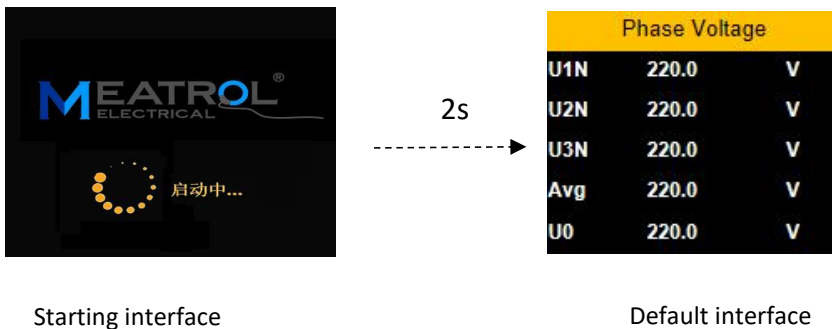

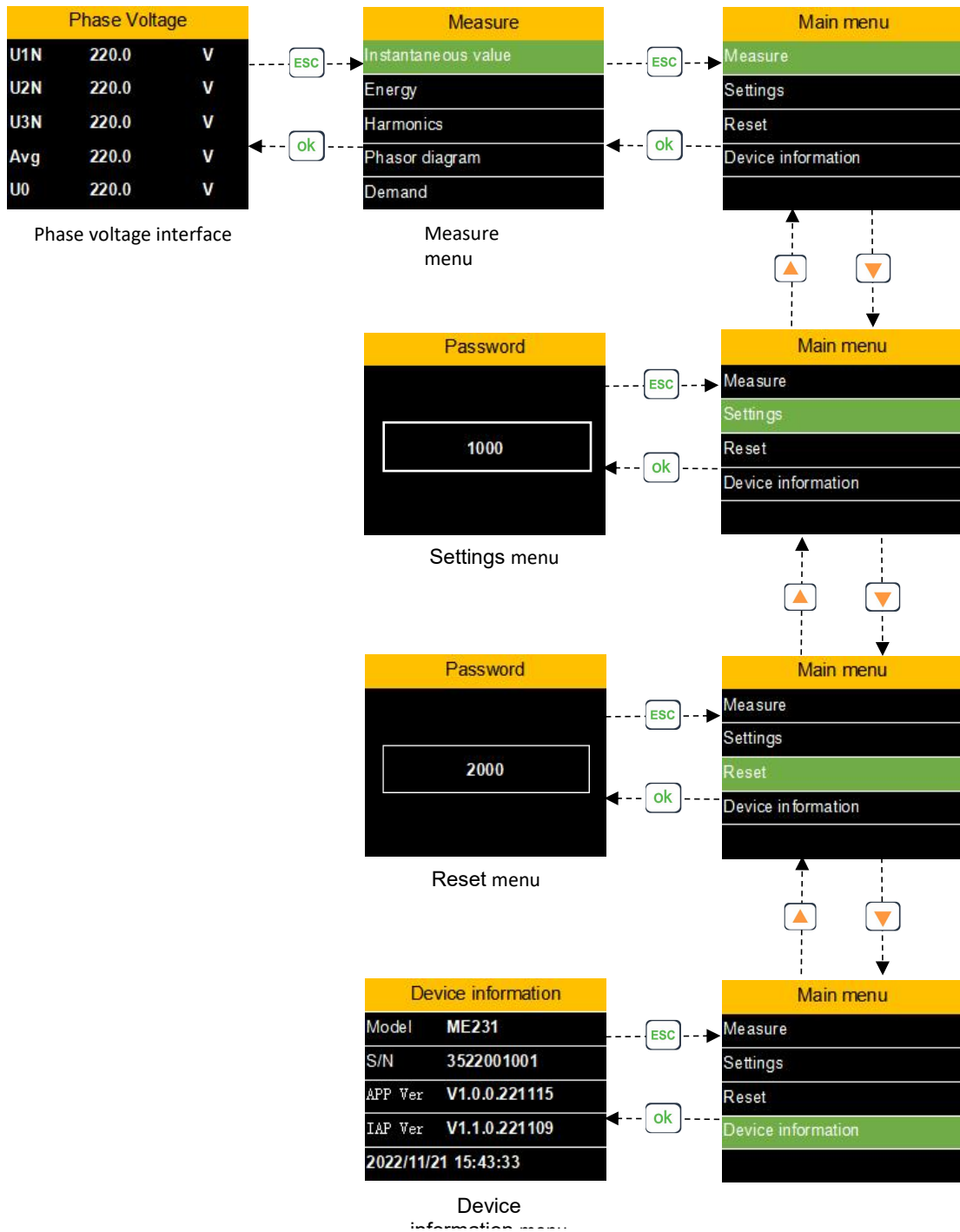

5.3 Meter display mode switching

Under the main menu of the ME231, there are four secondary menus: Measure menu, Settings menu, Reset menu and Device information menu. The switch between menus is shown in the figure below:



5.4 Measure menu interface

There are 7 sub-menus under the Measure menu: Instantaneous Value, Energy, Harmonics, Phase Diagram, Demand, unbalance, Max.&Min.

By pressing  or , To switch the display of the interface.

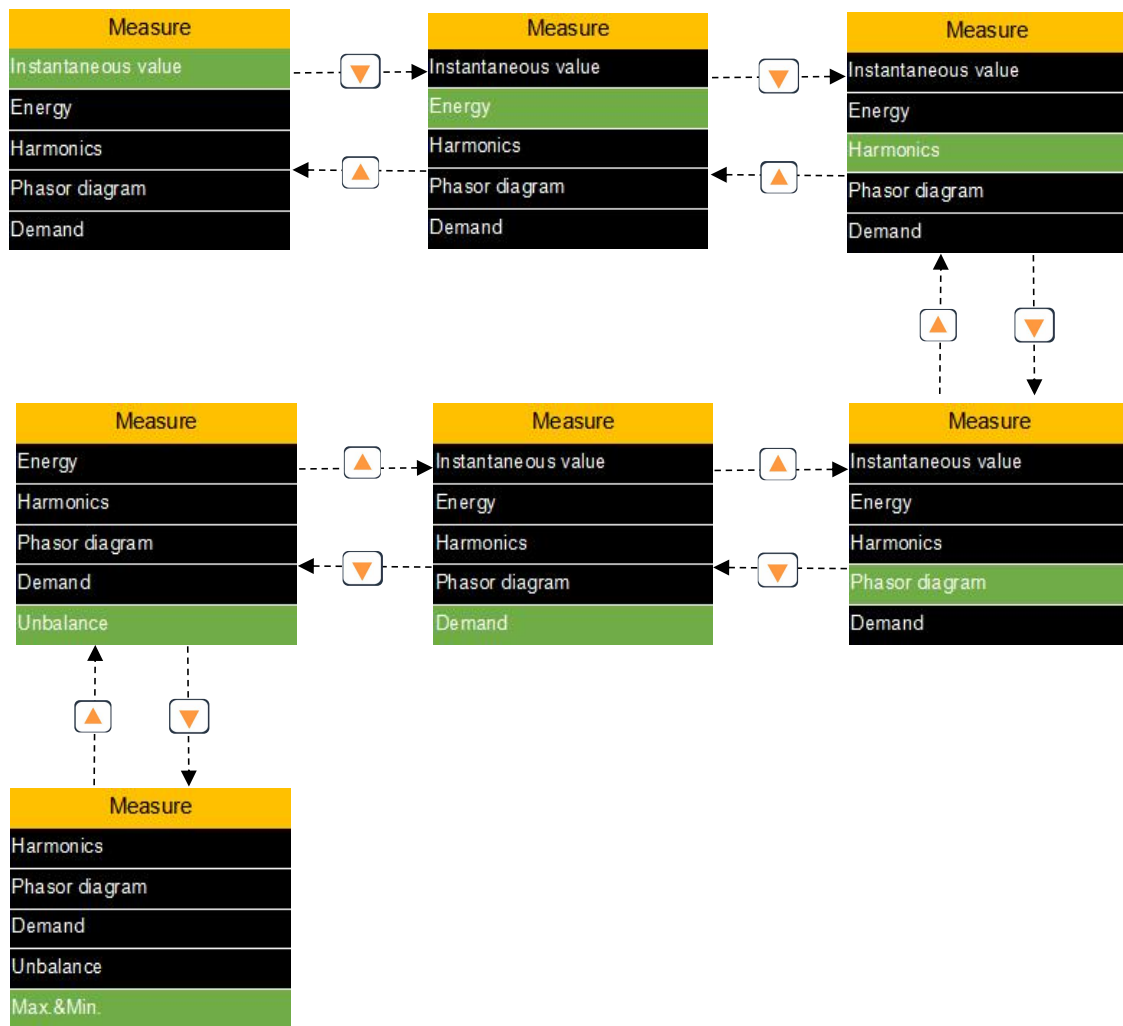

5.4.1 Measure menu-Instantaneous value interface

Instantaneous value interface is used to display: voltage, current, power, power factor, frequency and other data.

By pressing  or , To switch the display of the interface.





5.4.2 Measure menu-Energy interface

Energy interface is used to display: Active energy, Reactive energy, Apparent energy.

By pressing  or , To switch the display of the interface.



5.4.3 Measure menu-Harmonics interface

Harmonics interface is used to display: Voltage harmonics, current harmonics and other data. By pressing  or , ESC or OK key to switch the interface display.

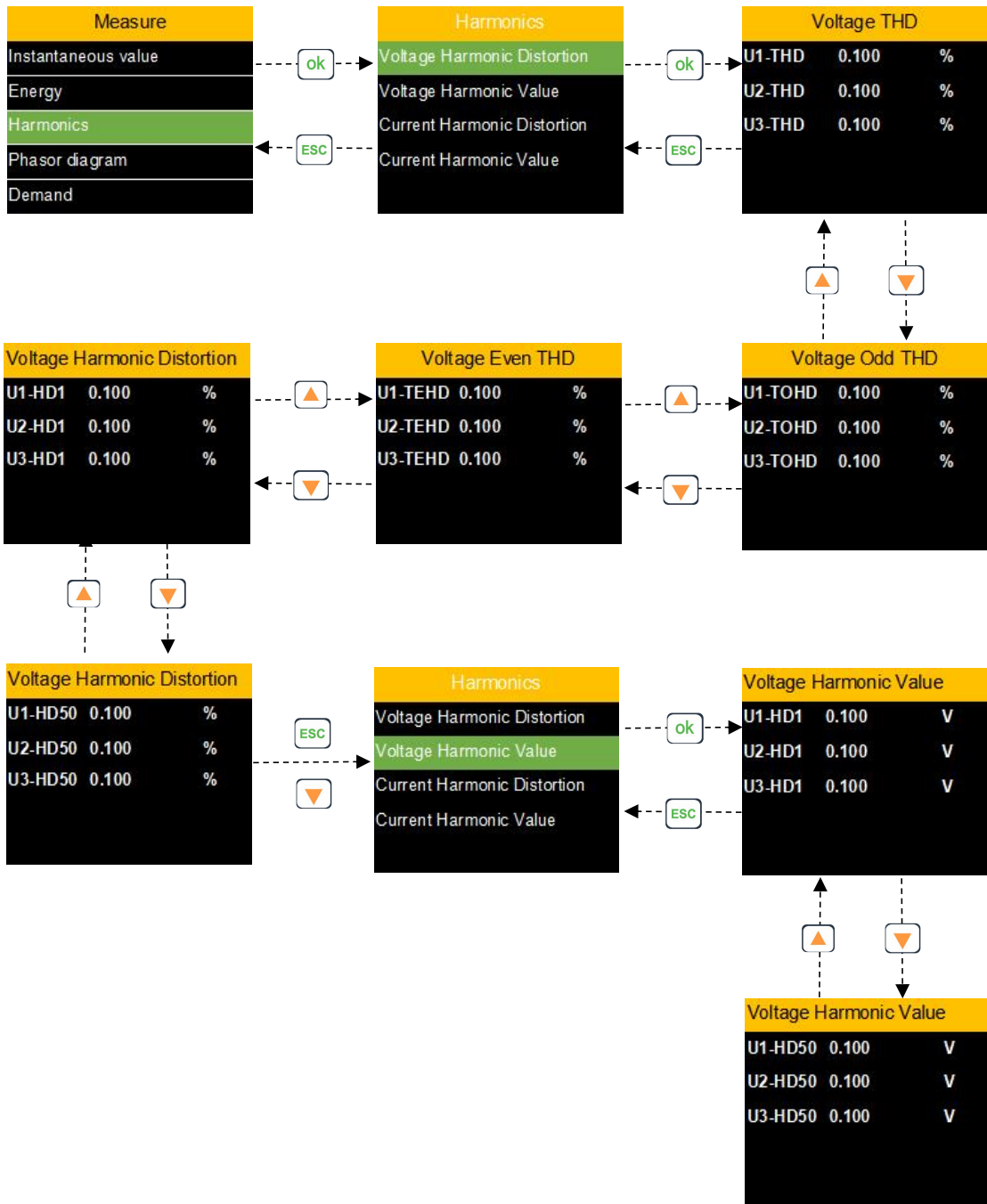

5.4.4 Measure menu- Phasor diagram interface

Phasor diagram interface is used to display: Phasor diagram, Phase Sequence, Angle and other data.

By pressing  or , To switch the display of the interface.

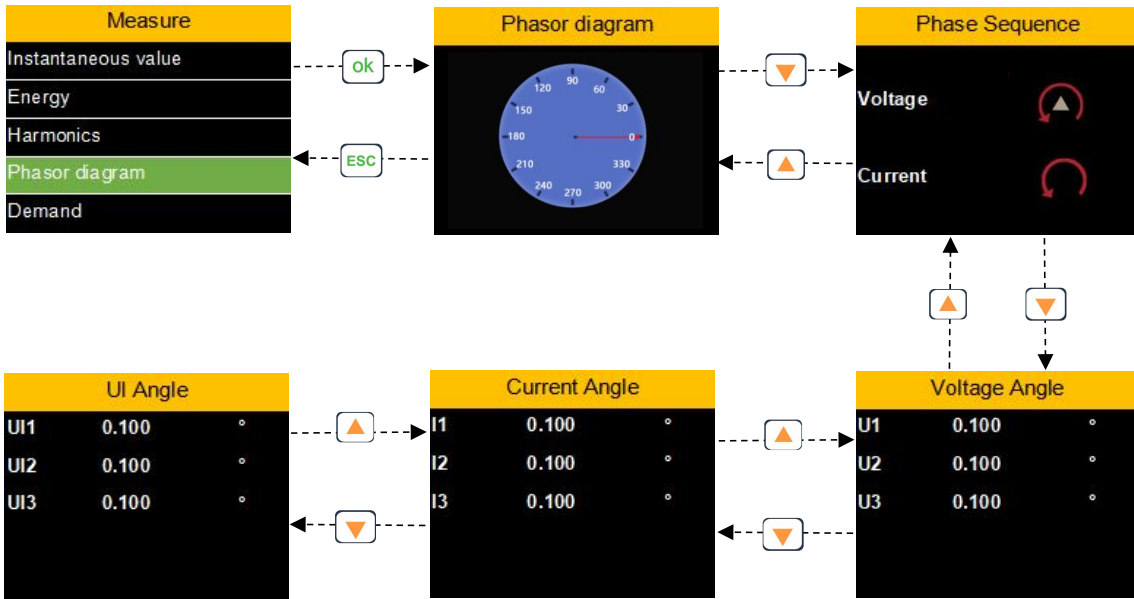

5.4.5 Measure menu- Demand interface

Demand interface is used to display: Active power, Reactive power, Apparent power DMD.

By pressing  or , To switch the display of the interface.

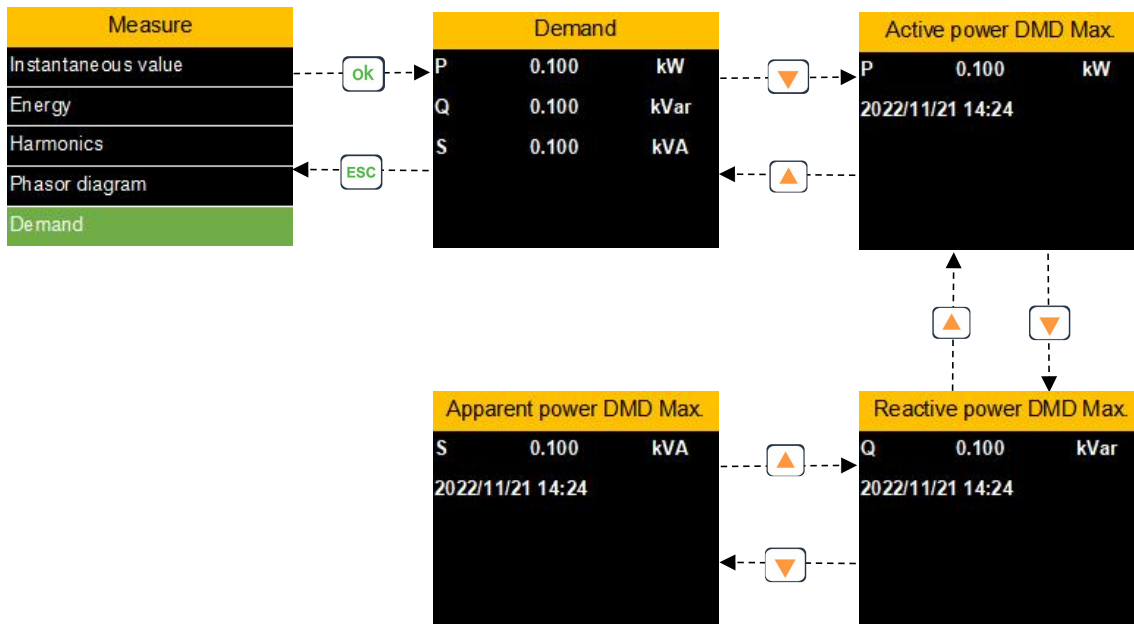

5.4.6 Measure menu- Unbalance interface

Unbalance interface is used to display: Voltage unbalance, current unbalance. By pressing

↑ or ↓, To switch the display of the interface.

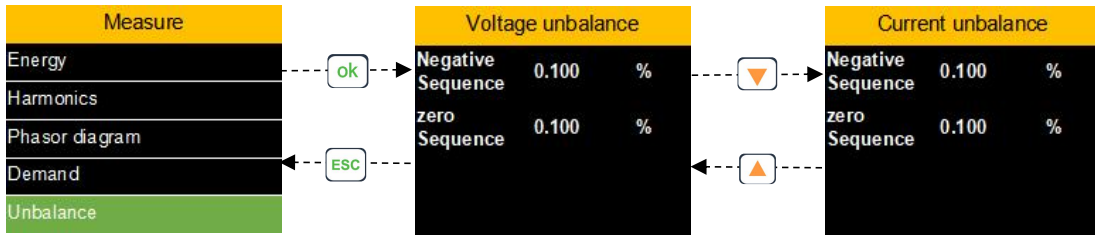

5.4.7 Measure menu- Max.&Min. interface

Max.&Min. interface is used to display: Voltage Max.&Min.,Current Max.&Min.and other data.By pressing ↑ or ↓, To switch the display of the interface.

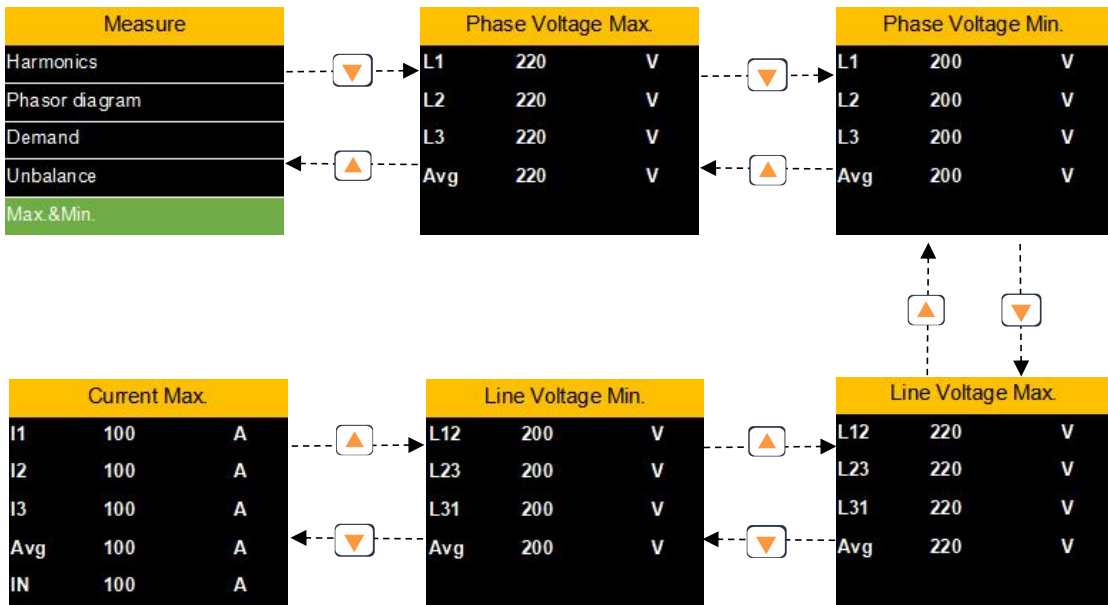

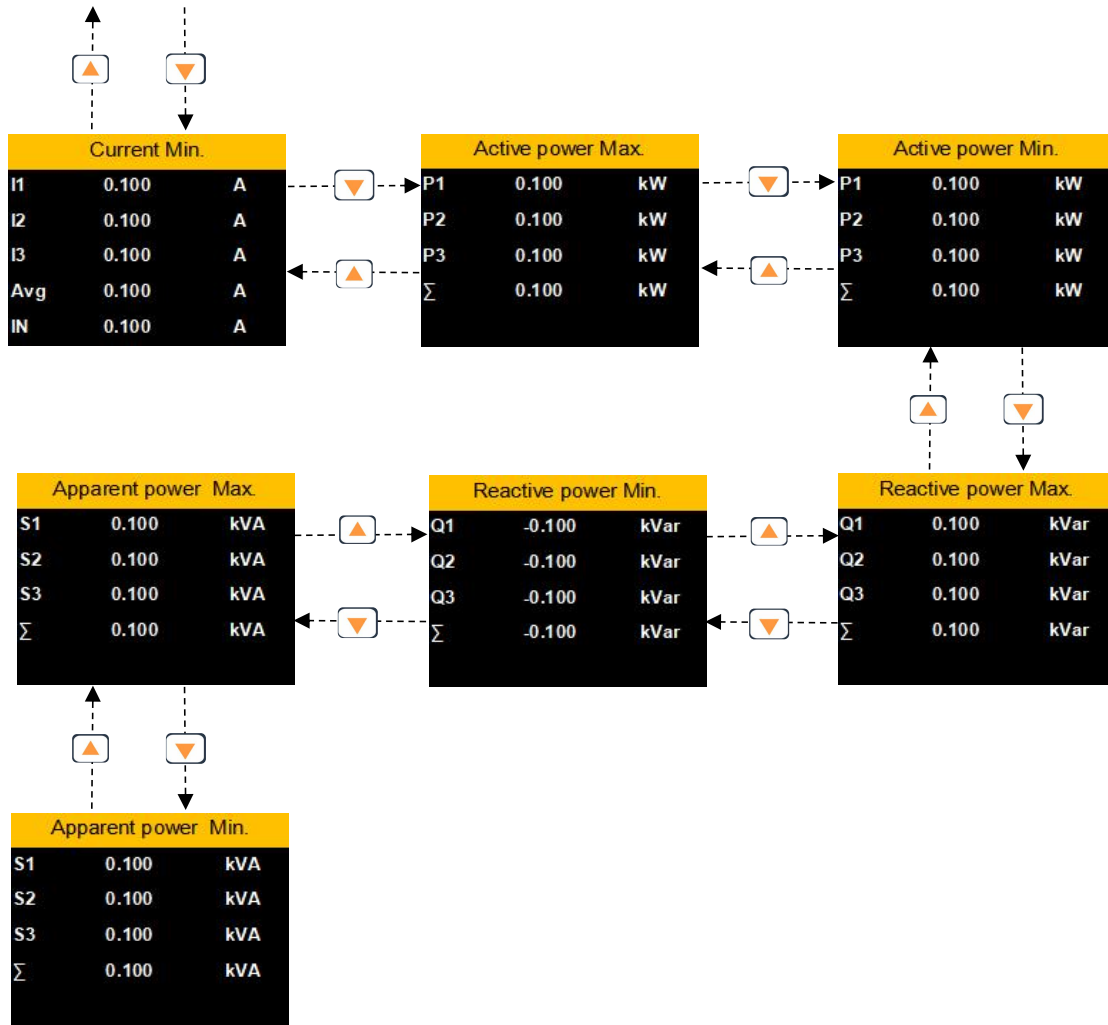

5.5. Settings menu interface

The setting menu is used for setting: Wire Type. Current sensor type and transformation ratio, voltage transformer transformation ratio, communication parameters, demand, backlight control, equipment time, password and other parameters.



Before enter the configuration page, you need to enter the configuration password (default 1000), By pressing OK Key Enter password, By pressing or , Modify value size, and Long press or to switch displacement, (the corresponding value will flash), if the password is correct, pressing OK Key it will enter the configuration interface. If not, continue to stay in the password input interface.

If you forget the configuration password, you can enter the last four digits of the device serial number to enter the configuration interface

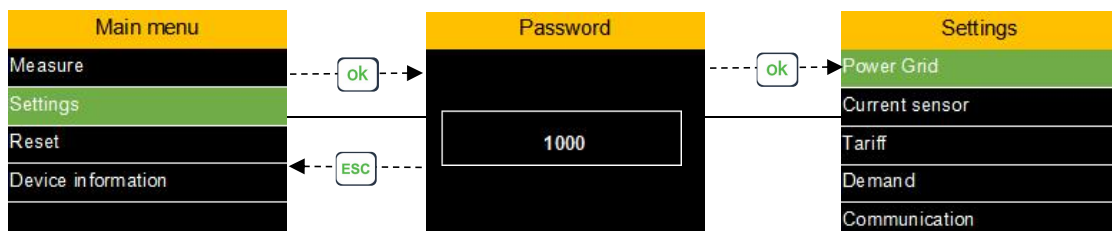
By pressing or , To switch the display of the interface, By pressing OK Key, Enter parameter configuration.



5.4.8 Settings menu -Power Grid interface

Press the OK key to enter the power grid setting, press the  or  modify the value. After the data modification is completed, there will be a prompt on whether to save it. Press the OK key or the ESC key to select whether to save the modification.

The power grid sub-menu can set the Wire Type, Frequency, Nominal Voltage, VT ratio and CT ratio.

Wire Type:3P4W 4CT, 3P4W 3CT, 3P3W 3CT, 3P3W 2CT, 1P3W, 1P2W

Frequency: 50\60



Nominal Voltage:00001-65535

VT ratio:1~10000, (primary end voltage / secondary end voltage).Unit V/V

CT ratio:1~10000, (primary end current / secondary end current).Unit A/A



5.4.9 Settings menu -Current sensor interface

Press the OK key to enter the Current sensor setting, press the  or  modify the value. After the data modification is completed, there will be a prompt on whether to save it. Press the OK key or the ESC key to select whether to save the modification.

The Current sensor sub-menu can set Phase Type, Sensor Type, Pri[A], Sec[mV], Nominal Current[A].

Phase Type:I1,I2,I3 \ In
 Sensor Type:Rcoil \ VCT
 Pri[A]:1-999999
 Sec[mV] (@50Hz/@60Hz) : 1-99999
 Nominal Current [A]: 1-99999

Parameter name	Explanation
Sensor type	Rcoil: Rogowski coil VCT: Voltage output type CT
Rcoil Pri	Rated primary current of Rogowski coil
Rcoil Sec	The secondary output value corresponding to the rated primary current
Nominal Current	The actual measured rated current value
For example,Coil Ratio:85mV/kA@50Hz, Rcoil Pri =1000A, Rcoil Sec=85mV, If measure 2000A, Nominal Current=2000A. If you want to measure 100A, change to keep 100 A nominal current.	
To replace the coil with different ratios, the Pri/Sec must be reset.	

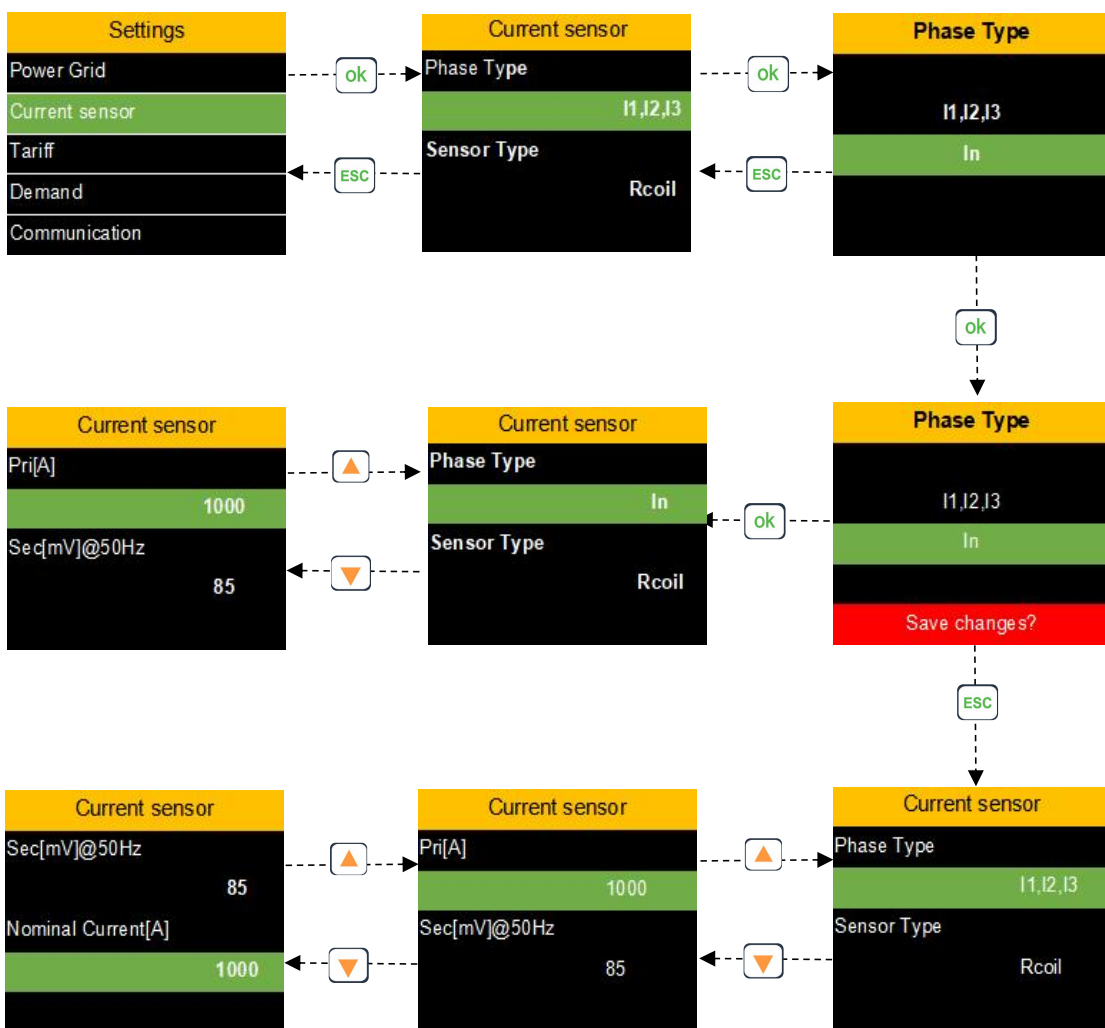

5.4.10 Settings menu -Tariff interface

Press the OK key to enter the Tariff setting, press the or modify the value. After the data modification is completed, there will be a prompt on whether to save it. Press the OK key or the ESC key to select whether to save the modification.

The Tariff sub-menu can set Switch Mode, Start time, Tariff select.

Switch Mode: Manual\RTC

RTC Mode:



Can set Ta, Tb, Tc, Td, Te, Tf, 6 Start time and 6 Tariff select.

Manual Mode:

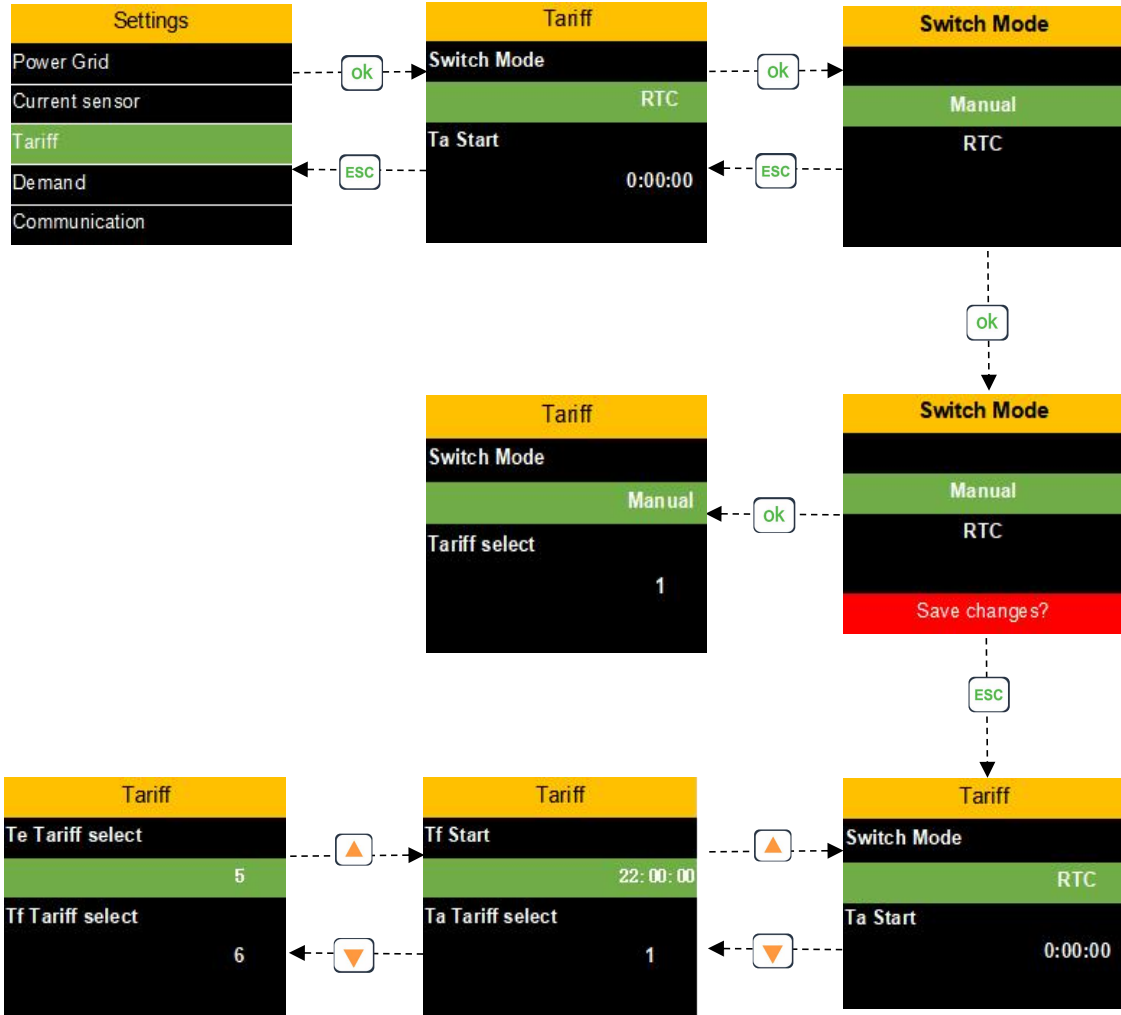
Can set Ta, Tb, Tc, Td, Te, Tf, 6 Tariff select.



5.4.11 Settings menu -Demand interface

Press the OK key to enter the Demand setting, press the  or  modify the value. After the data modification is completed, there will be a prompt on whether to save it. Press the OK key or the ESC key to select whether to save the modification.

The Demand sub-menu can set Method, Block[minute]

Parameter name	Explanation
Calculation method	Fixed: update the demand according to the calculation interval Sliding type: update the demand once a minute
Calculation interval	Unit: minutes Range: 1-60 Default: 15 minutes

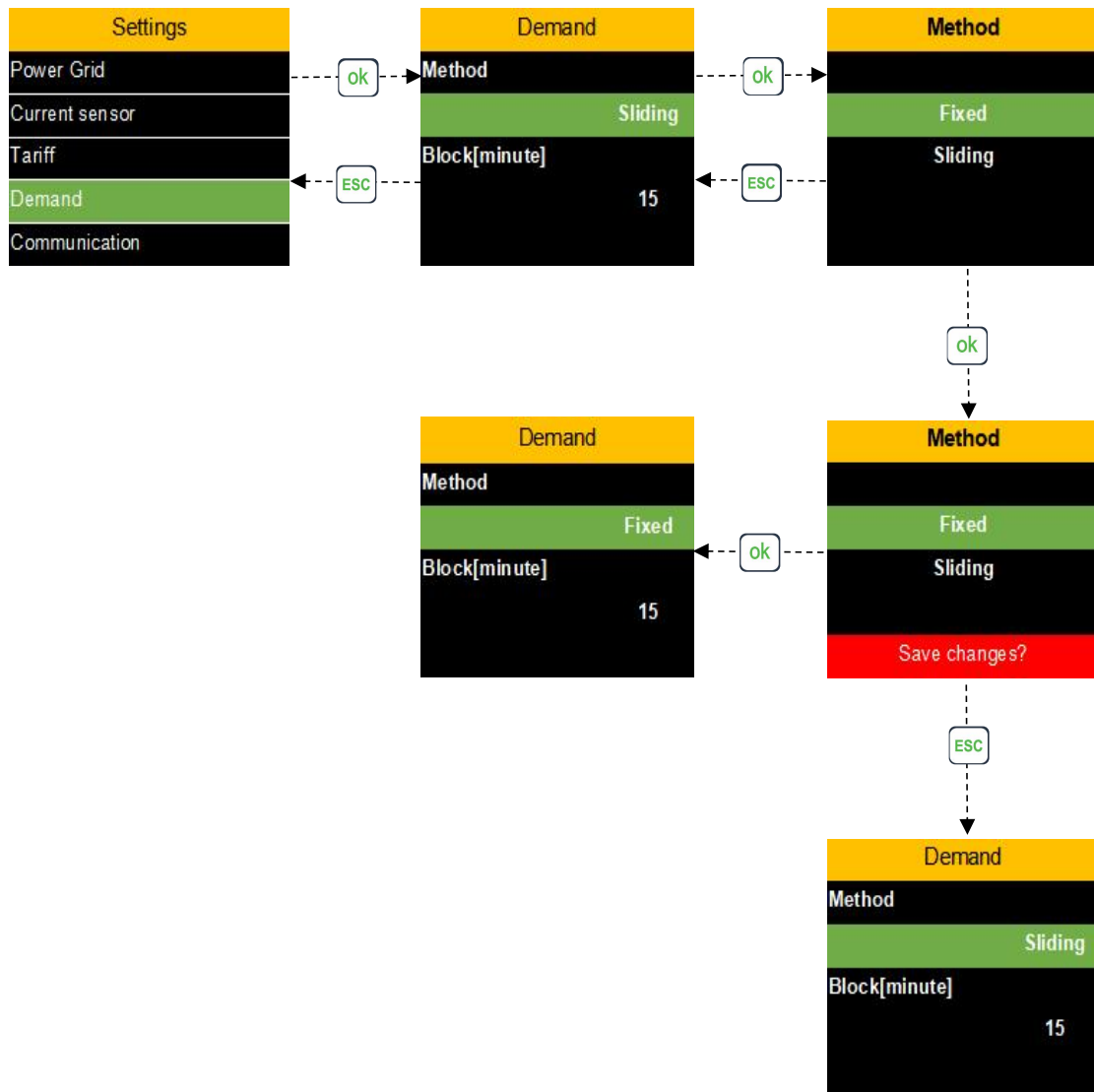

5.4.12 Settings menu -Communication interface

Press the OK key to enter the Communication setting, press the or modify the value. After the data modification is completed, there will be a prompt on whether to save it. Press the OK key or the ESC key to select whether to save the modification.

The Communication sub-menu can set Status, Device ID, Baud rate[bps], Parity, Stop bits.

Status: Enable \ Disable

Device ID: 000-247



Baud rate[bps]: 2400, 4800, 9600, 19200, 38400

Parity:None, Odd, Even

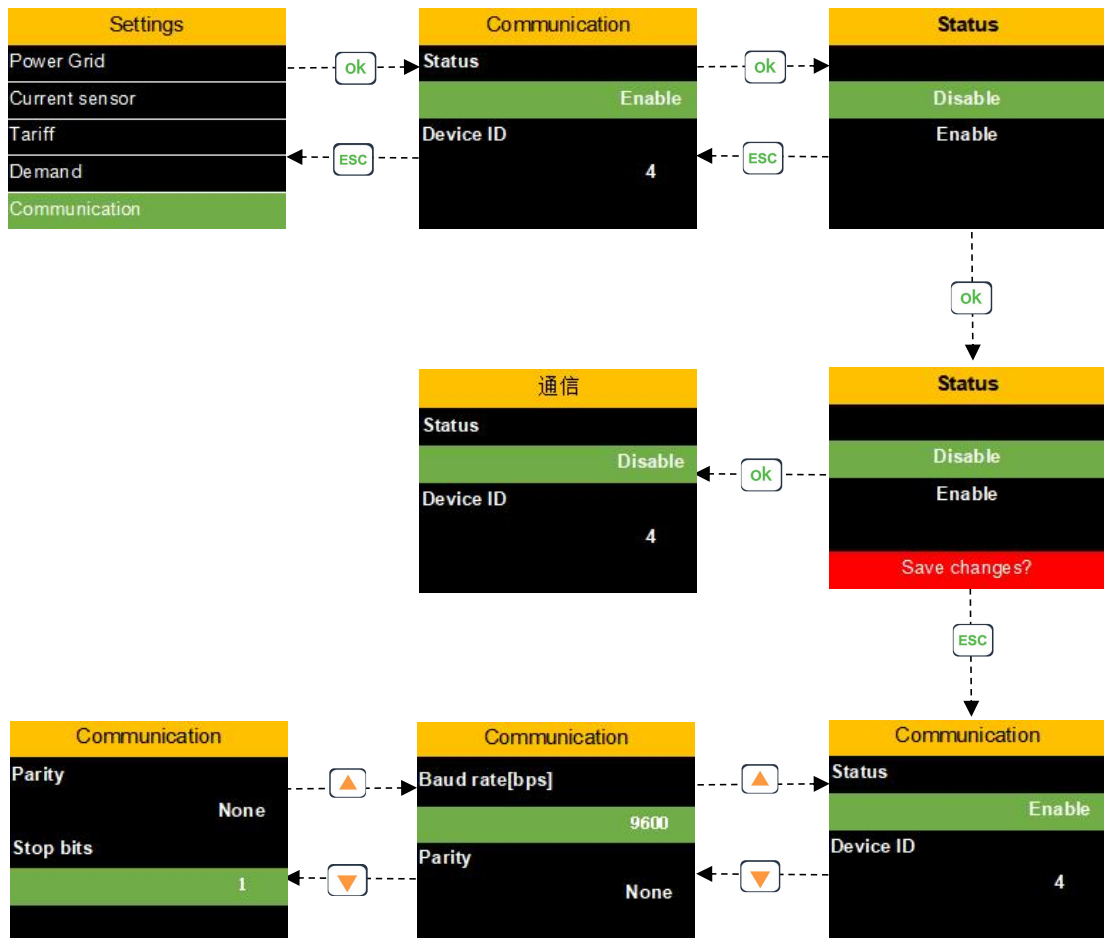
Stop bits:1 \ 2



5.4.13 Settings menu -HMI interface

Press the OK key to enter the HMI setting, press the  or  modify the value. After the data modification is completed, there will be a prompt on whether to save it. Press the OK key or the ESC key to select whether to save the modification.

The HMI sub-menu can set Language, Clock, Key Tone, Backlight OFF, Backlight Brightness.

Language: 中文 \ English

Clock: Year / month / day time: minutes: seconds





Key Tone: Enable \ Disable

Backlight OFF: Never \ 1 minute \ 2 minutes \ 3 minutes \ 4 minutes \ 5 minutes

Backlight Brightness: 1-5



5.4.14 Settings menu -Password interface

Press the OK key to enter the Password setting, press the  or  modify value size, and Long press  or  to switch displacement(the corresponding value will flash).

Then press the OK key or the ESC key to select whether to save the modification.

The Password sub-menu can set settings password, reset password.



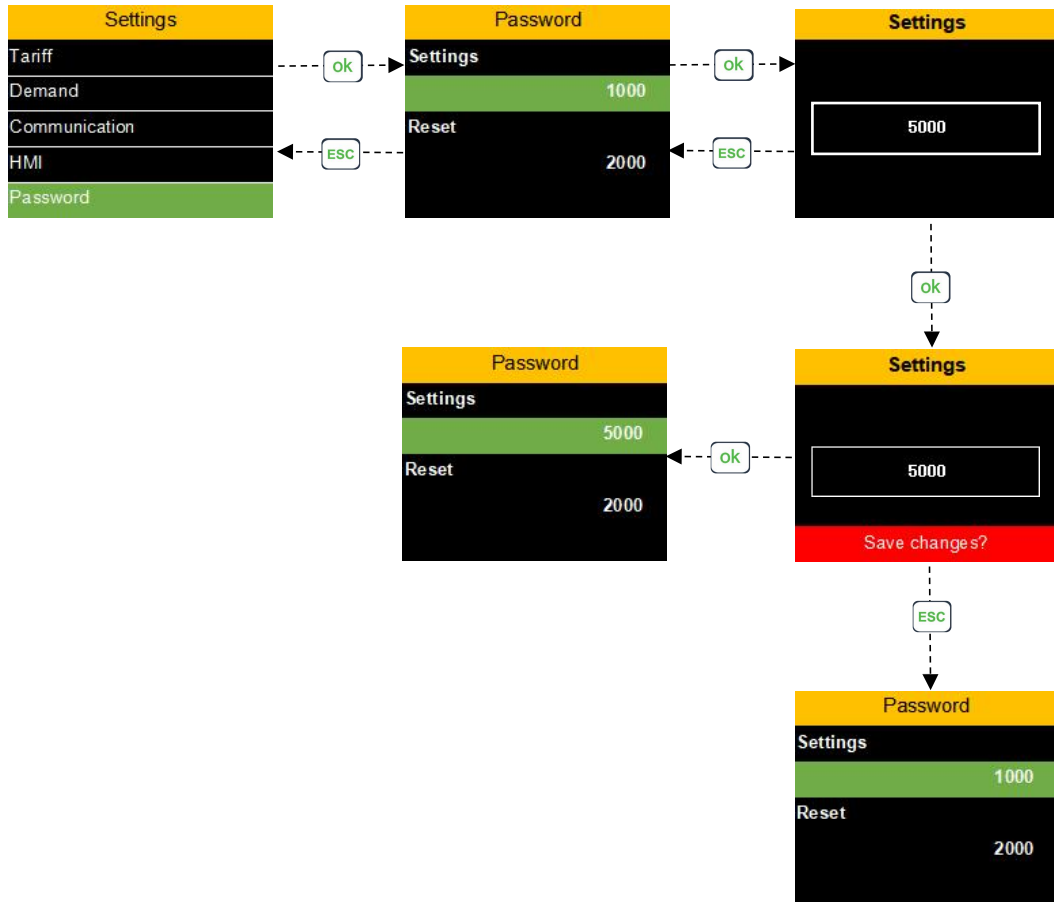

Settings password: 0001-9999

Reset password: 0001-9999





5.5 Reset menu interface

The reset menu is used for resetting Max.Min., Demand Max., Tariff Energy, Energy and Factory Set.

Before enter the configuration page, you need to enter the configuration password (default 2000), By pressing OK Key Enter password, By pressing  or , Modify value size, and Long press  or  to switch displacement, (the corresponding value will flash), if the password is correct, pressing OK Key it will enter the configuration interface. If not, continue to stay in the password input interface.

If you forget the configuration password, you can enter the last four digits of the device serial number to enter the configuration interface

By pressing  or , To switch the display of the interface, By pressing OK Key, Enter parameter configuration.

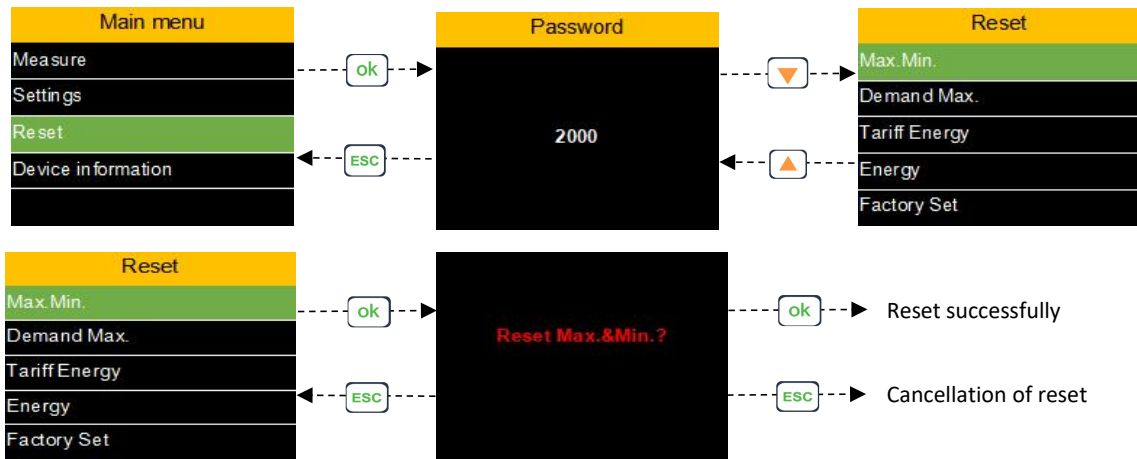

5.6 Device information menu interface

The device information menu is used to display: Device model, S/N, Firmware, Communication, Power grid parameters, and other data.

By pressing  or , To switch the display of the interface.

The Device information menu is shown in the figure below:



6 Modbus Communication

Communication	
Communication port	RS485
Communication protocol	Modbus RTU

ME231 adopts the standard Modbus RTU protocol.

6.1 Modbus Communication settings

Before performing the Modbus-RTU communication, the following parameters need to be set through the interface of the meter:

parameter	Effective value	Default value
Address	1-247	1
Baud rate	-1200 -2400 -4800 -9600 -19200 -38400 -57600 -115200	9600
Data bits	8	8
Parity check	- None - Odd - Even	None
Stop bit	1-2	1

6.2 Modbus-RTU data frame

Modbus RTU data frame includes 4 parts: Address field, Function code, Data and Error verification.

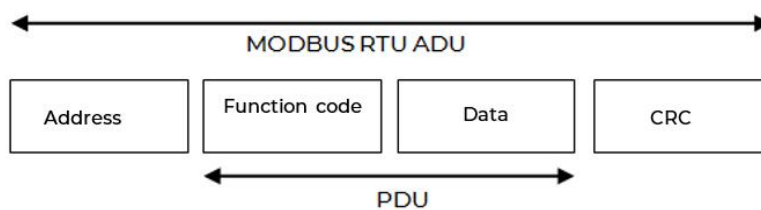

6.3 PDU Request data Format

Function code	Data
8-Bits	N×8-Bits

6.3.1 Function code

Function codes are used to indicate how the analyzer processes the instruction. The following table shows the available function codes and their descriptions.

Function code		Name of function code	Function	Remarks
Decimal system	Hexadecimal			
3	03H	Read holding register	Used to read meter's parameters	
16	10H	Write multiple registers	Used to configure meter parameters	

6.3.2 Register list

The register list has the following entries:

Register name	Register address	operation	register	type	Unit	description
		Read / write	number			

- Register name: used to indicate the purpose of the register.
- Register address: the address of Modbus register in decimal system.
- Operation: used to indicate the operation that the register can perform.
- Number of registers: indicates how many int16 sizes the register has.
- Type: describes the type of data
- Unit: indicates the size of the register value unit
- Description: a description of the register

6.3.3 Data type list

The following table lists the data types used in this document:

Type	description	Range
UInt16	16 bit unsigned integer	0–65535
Int16	16 bit signed integer	-32768–+32767
UInt32	32 bit unsigned integer	0–4 294 967 295
UInt64	64 bit unsigned integer	0–18 446 744 073 709 551 615
UTF8	8-bit UTF	Multibyte unicode coding
Float32	32-bit floating point number	Standard IEEE single precision floating point numbers
Date Time	Date and Time Types	-
Time	Time Type	-

Date Time format:

Byte	Position															
	15	14	13	12	11	10	9	8	7	6	5	4	3	2	1	0
1	Year (2000–2099)															
2	Month (1–12)								Day (1–31)							
3	Hour (0–23)								Second (0–59)							
4	Millisecond (0–59)															

Time format:

Byte	Position															
	15	14	13	12	11	10	9	8	7	6	5	4	3	2	1	0
1	Hour (0–23)															
2	Second (0–59)															
3	Millisecond (0–59)															

6.3.4 Configure the device via the Modbus-RTU

You can use the function code 16 to write instructions to the device and configure the device parameters.

The device parameter configuration can only be configured by writing the corresponding data to the "configuring instruction register", that is, writing the corresponding data to the address starting from 300 to configure the corresponding parameters.

Configuration results:

The configuration results can be obtained by reading registers 424 and 425.

Register address	Description	Size (UInt16)	Data (example)
424	Configuration instruction code	1	1001(set Date Time)
425	Configuration results	1	0 = configuration successful 80 = invalid instruction code 81 = invalid parameter value 82 = number of invalid parameters 83 = instruction not executed

6.4 Modbus-RTU Function code

6.4.1 Function code (0x10=16) Operation Instructions

Function code(0x10=16)is used to configure the parameters of the device, and its request and return instructions are defined as follows:

Configuration device parameter command format:

Serial number	Significance	Type	Range(Decimal system)	Description
1	Device address	UInt8	1-247	
2	Function code	UInt8	16	
3	Register start address	UInt16	-	High byte first(sending sequence)
4	Number of configuration registers	UInt16	1-123	High byte first(sending sequence)
5	Data length	UInt8		Number of configuration registers * 2
6	First register configuration data	UInt16	-	High byte first(sending sequence)
7	...	UInt16	-	High byte first(sending sequence)
8	nth register configuration data	UInt16	-	High byte first(sending sequence)
9	CRC-16 parity code	UInt16	-	low byte first(sending sequence)

Return to configuration device parameter command format:

Serial number	Significance	Type	Range(Decimal system)	Description
1	Device address	UInt8	1-247	
2	Function code	UInt8	16	
3	Register start address	UInt16	300	High byte first
4	Number of configuration registers	UInt16	1-123	High byte first
5	CRC-16 parity code	UInt16	-	low byte first

Attention!

The function code (0x10=16) can only write data to the "configuration instruction register", that is, it can only write data to the register starting from address 300.

For example:

Configure the analyzer time (command =1200, set to: 2022-11-1 12:20:00)

Serial No.	Name	Type	Value (Decimal system)	Value (HEX)	Description
1	Device address	UInt8	1	01	
2	Function code	UInt8	16	10	
3	Data byte length	UInt16	300	012C	Configuration register start address
4	Number of read registers	UInt16	7	0007	Configure Time Command + parameter total 7 registers are occupied
5	Data length	UInt8	14	0E	Number of configuration registers * 2
6	Register 300 write value	UInt16	1200	04B0	Instruction code 1200 to configure time
7	Register 301 write value	UInt16	2022	07E6	Year of configuration time = 2022
8	Register 302 write value	UInt16	11	000B	Month of configuration time = 11
9	Register 303 write value	UInt16	1	0001	Day of configuration time = 1
10	Register 304 write value	UInt16	12	000C	Time of configuration = 12
11	Register 305 write value	UInt16	20	0014	Minutes of configuration time =20
12	Register 306 write value	UInt16	0	0000	Seconds of configuration time = 0
13	CRC-16 parity code	UInt16	35524	8AC4	low byte first(sending sequence)

The order of sending bytes is as follows:

01 10 01 2C 00 07 0E 04 B0 07 E6 00 0B 00 01 00 0C 00 14 00 00 C4 8A

After the configuration is successful,the received data packets are as follows:

01 10 01 2C 00 07 41 FE

Serial number	Significance	Type	Value (decimal)	Value (HEX)
1	Device address	UInt8	01	1

Serial number	Significance	Type	Value (decimal)	Value (HEX)
2	Function code	UInt8	10	16
3	Register start address	UInt16	012C	300
4	Number of configuration registers	UInt16	0007	7
5	CRC-16 parity code	UInt16	41FE	

6.4.2 Function code (0x03=3) operation instructions

The function code (0x03=3) is used to read the parameters of the analyzer register. Its request data and return data format are as follows:

Request data format:

Serial No.	Name	Type	Range (Decimal system)	Description
1	Device address	UInt8	1-247	
2	Function code	UInt8	3	
3	Register start address	UInt16	-	High byte first(sending sequence)
4	Number of read registers	UInt16	1-125	High byte first(sending sequence)
5	CRC-16 parity code	UInt16	-	low byte first(sending sequence)

Return data format:

Serial No.	Name	Type	Range (Decimal system)	Description
1	Device address	UInt8	1-247	
2	Function code	UInt8	3	
3	Data byte length	UInt8	-	Number of registers * 2
4	1st register data		-	High byte first
5	...		-	High byte first
6	nth register data		-	High byte first
7	CRC-16 parity code	UInt16	-	Low byte first

Example of reading device parameters:

Read the voltage values of L1, L2 and L3 (the starting address of the voltage register is 1010):

Serial No.	Name	Type	Range (Decimal system)	Range (HEX)	Description
1	Device address	UInt8	1	0x01	
2	Function code	UInt8	3	0x03	
3	Register start address	UInt16	1010	0x03F2	
4	Number of read registers	UInt16	6	0x0006	

Serial No.	Name	Type	Range (Decimal system)	Range (HEX)	Description
5	CRC-16 parity code	UInt16	32612	0x7F64	low byte first(sending sequence)

The order of sending hexadecimal bytes is as follows:

01 03 03 F2 00 06 64 7F

The received packets are as follows:

01 03 0C 43 5C 00 00 43 5D 00 00 43 5E 00 00 14 AC

Serial No.	Name	Type	Hexadecimal	Decimal system
1	Device address	UInt8	01	1
2	Function code	UInt8	03	3
3	Data byte length	UInt8	0C	12
4	Address 2147 data (phase a voltage)	float32	435C0000	220V
5	Address 2148 data (phase B voltage)	float32	435D0000	221V
6	Address 2149 data (phase C voltage)	float32	435E0000	222V
7	CRC-16 parity code	UInt16	14AC	

6.4.3 Error response

Error response data format:

Serial No.	Name	Type	Decimal system	Hexadecimal	Description
1	Device address	UInt8	1-247	0x01-0xF7	
2	Function code	UInt8	(128+3) (128+16)	(0x80+0x03) (0x80+0x10)	
3	Error code	UInt8			
4	CRC-16 parity code	UInt16			low byte first(sending sequence)

Modbus Error code:

Code (HEX)	Name	Meaning
0x01	Illegal function code	The function code supported by the analyzer is not used.
0x02	Illegal data address	The register data written or read is not a supported address range.
0x03	Illegal data value	The data value written to the register does not meet the requirements.
0x04	Analyzer error	An unknown error occurred

6.5 List of configuration instructions

6.5.1 System parameter setting

Instruction code	Operation	Size	Type	Unit	Range (Decimal system)	Description
1001	W	1	UInt16	-	0,1,2,3,4,5	Wiring mode 0=3P4W_4CT 1=3P4W_3CT 2=3P3W_3CT 3=3P3W_2CT 4=1P3W 5=1P2W
	W	1	UInt16	Hz	50,60	Grid frequency
	W	1	UInt16	V	1-65535	Nominal voltage (not including VT ratio)
	W	2	UInt32	-	1-99999999	VT ratio, 10000 times magnification
	W	2	UInt32	-	1-99999999	CT ratio, 10000 times magnification

6.5.2 Parameter setting of L1,L2,L3 current transformer

Instruction code	Operation	Size	Type	Unit	Range (Decimal system)	Description
1002	W	1	UInt16	-	0,1	Phase L1L2L3 current access mode 0 = Rogowski coil access 1 = VCT access
	W	2	UInt32	A	1-999999	Phase L1L2L3 Rogowski coil input value
	W	2	UInt32	mV@50 Hz mV@60 Hz	1-99999	Phase L1L2L3 Rogowski coil output =Actual value*100(Note: The output should be set according to the set power grid frequency)
	W	2	UInt32	A	1-999999	Nominal current of phase L1L2L3 Rogowski coil
	W	2	UInt32	A	1-999999	Phase L1L2L3 VCT input value
	W	2	UInt32	mV	1-99999	Phase L1L2L3 VCT output =Actual value*100
	W	2	UInt32	A	1-999999	VCT nominal current of phase L1L2L3

6.5.3 Parameter setting of N-phase current transformer

Instruction code	Operation	Size	Type	Unit	Range (Decimal system)	Description
1003	W	1	UInt16	-	0,1	Phase N current access mode 0 = Rogowski coil access 1 = VCT access
	W	2	UInt32	A	1-999999	Phase N Rogowski coil input value
	W	2	UInt32	mV@50 Hz mV@60 Hz	1-99999	Phase N Rogowski coil output =Actual value*100(Note: The output should be set according to the set power grid frequency)
	W	2	UInt32	A	1-999999	Nominal current of phase N Rogowski coil
	W	2	UInt32	A	1-999999	Phase N VCT input value
	W	2	UInt32	mV	1-99999	Phase N VCT output =Actual value*100
	W	2	UInt32	A	1-999999	VCT nominal current of phase N

6.5.4 Zero drift suppression setting

Instruction code	Operation	Size	Type	Unit	Range (Decimal system)	Description
1020	W	1	UInt16	%	0~1000	Voltage zero drift suppression Take (nominal voltage * VT variable ratio) as a reference = Actual value * 100 Default: 10
	W	1	UInt16	%	0~1000	Current zero drift suppression With (nominal current * CT change ratio) as a reference = Actual value * 100 Default: 10

6.5.5 Demand parameter setting

Instruction code	Operation	Size	Type	Unit	Range (Decimal system)	Description
1060	W	1	UInt16	-	0,1	Demand calculation method 0= fixed 1= sliding type
	W	1	UInt16	minute	1-60	Demand calculation interval

6.5.6 Tariff mode setting

Instruction code	Operation	Size	Type	Unit	Range (Decimal system)	Description
1070	W	1	UInt16	-	0,1	Switch mode 0 = Manual 1 = RTC

6.5.7 Manual tariff setting

Instruction code	Operation	Size	Type	Unit	Range (Decimal system)	Description
1071	W	1	UInt16	-	0-5	Manual tariff setting 0 = Tariff select 1 1 = Tariff select 2 ... 5 = Tariff select 6 <i>(Note: This setting is only valid if the tariff mode is manual switching)</i>

6.5.8 RTC tariff period setting

Instruction code	Operation	Size	Type	Unit	Range (Decimal system)	Description
1072	W	3	Time	-	-	Ta Start
	W	3	Time	-	-	Tb Start
	W	3	Time	-	-	Tc Start
	W	3	Time	-	-	Td Start
	W	3	Time	-	-	Te Start
	W	3	Time	-	-	Tf Start

6.5.9 RTC tariff select setting

Instruction code	Operation	Size	Type	Unit	Range (Decimal system)	Description
1073	W	1	UInt16	-	0-5	Ta Tariff select 0 = Tariff 1 1 = Tariff 2 ... 5= Tariff 6
	W	1	UInt16	-	0-5	Tb Tariff select
	W	1	UInt16	-	0-5	Tc Tariff select
	W	1	UInt16	-	0-5	Td Tariff select
	W	1	UInt16	-	0-5	Te Tariff select
	W	1	UInt16	-	0-5	Tf Tariff select

6.5.10 Device time setting:

Instruction code	Operation	Size	Type	Unit	Range (Decimal system)	Description
1200	W	1	UInt16	-	2000-2099	Year
	W	1	UInt16	-	1-12	Month
	W	1	UInt16	-	1-31	Date
	W	1	UInt16	-	0-23	Hour
	W	1	UInt16	-	0-59	Minute
	W	1	UInt16	-	0-59	Second

6.5.11 Communication parameter setting

Instruction code	Operation	Size	Type	Unit	Range (Decimal system)	Description
1210	W	1	UInt16	-	1-247	Slave address
	W	1	UInt16	-	0-6	Baud rate 0 = 2400 1 = 4800 2 = 9600 3 = 19200 4 = 38400 5 = 57600 6 = 115200
	W	1	UInt16	-	0, 1, 2	Parity check 0 = none check 1 = odd check 2 = even check

	W	1	UInt16	-	1,2	Stop bit 1 = 1bit 2 = 2bit
--	---	---	--------	---	-----	----------------------------------

6.5.12 Reset setting

Instruction code	Operation	Size	Type	Unit	Range (Decimal system)	Description
1301	W	1	UInt16	-	1-5	1: Reset Max.Min. 2: Reset Demand Max 3: Reset Tariff Energy 4: Reset Energy 5: Reset ALL

6.5.13 Relay output control mode

Instruction code	Operation	Size	Type	Unit	Range (Decimal system)	Description
2000	W	1	UInt16	-	0-1	Control mode 0 = Manual 1 = Alarm

6.5.14 Relay output manual control

Instruction code	Operation	Size	Type	Unit	Range (Decimal system)	Description
2001	W	1	UInt16	-	0-1	Relay output control 0 = open relay output 1 = closed relay output <i>(Note: This setting is effective only when the relay output control mode is manual control mode)</i>

6.5.15 Alarm setting

Instruction code	Operation	Size	Type	Unit	Range (Decimal system)	Description
3000	W	1	UInt16	-	-	Alarm ID
	W	1	UInt16	-	0,1	Alarm Status 0=Disable 1=Enable
	-	1	UInt16	-	-	Reserve

Instruction code	Operation	Size	Type	Unit	Range (Decimal system)	Description
	W	2	Float32	-	0-1000000	Alarm activation threshold
	W	2	Float32	%	-	Percentage error of alarm release point relative to alarm activation threshold Example: over current alarm activation threshold =100A alarm release point =5%. When the current value is less than $100-100*5\%=95A$, the alarm will be released
	W	1	UInt16	-	0,1	Buzzer 0=Unlinked 1=Linked
	W	1	UInt16	-	0,1	Relay 0=Unlinked 1=Linked

6.6 Register list

The register list has the following headings:

Register alias	Register address	Operation read / write	Size	Type	Unit	Description
----------------	------------------	------------------------	------	------	------	-------------

- Register alias: Used to refer to the meaning of registers
- Register address: The initial address of Modbus communication register is in **decimal format, and the address is the real address without offset.**
- Operation: Indicates the operation that the register can perform, R: readable; W: It can be written directly through 16 function code; WC: the current register needs to be configured indirectly by writing configuration data to the address starting from the instruction register 300.
- Size: Indicates how many MODBUS registers are occupied. One MODBUS register is 16bit.
- Type: For the type of data code, see the Data type table
- Unit: Unit of register value
- Description: Introduce the function of this register.

Data type table

Type	Description	Range
UInt16	Unsigned 16 bits integer	0~65535
Int16	Signed 16 bits integer	-32768~+32767
UInt32	Unsigned 32-bit integer	0~4294967295
UInt64	Unsigned 64 bits integer	0~18446744073709551615
Int64	Signed 64 bits integer	-9223372036854775808 ~ 9223372036854775808
UTF8	8-bit UTF code	Multibyte Unicode encoding
Float32	32-bit floating point	Standard IEEE floating point data (single precision)
Date Time	Time type	-

Date Time format

Byte	Position															
	15	14	13	12	11	10	9	8	7	6	5	4	3	2	1	0
1	Year (2000–2099)															
2	Month (1–12)								Date (1–31)							
3	Hour (0–23)								Minute (0–59)							
4	Millisecond (0–59999)															

6.7 Modbus Register list

6.7.1 Equipment parameters:

Register alias	Register initial address (decimal)	Operation read / write	Size	Type	Unit	Description
Meter model	60	R	10	UTF8	-	
Serial No.	70	R	2	UInt32	-	
APP Version No.	72	R	1	UInt16	-	Format: X.Y
Date and time	75	R/WC	4	Date time	-	Reg.75: Year 2000-2099 Reg.76: Month (b15:b8), Date (b7:b0) Reg. 77: Hour (b15:b8) ,Minute (b7:b0) Reg. 78: Millisecond

6.7.2 Communication parameter:

Register alias	Register initial address (decimal)	Operation read / write	Size	Type	Unit	Description
Slave address	80	R/WC	1	UInt16	-	1-247
Baud rate	81	R/WC	1	UInt16	-	0=2400 1=4800 2=9600 3=19200 4=38400
Parity	82	R/WC	1	UInt16	-	0 = None 1 = Odd 2 = Even
Stop bit	83	R/WC	1	UInt16	-	0 = 1 bit 1 = 2 bit

6.7.3 Relay

Register alias	Register initial address (decimal)	Operation read / write	Size	Type	Unit	Description
Output control mode	200	R/WC	1	UInt16	-	Relay output control mode 0 = Manual control mode 1 = alarm output control mode
Relay output control	201	R/WC	1	UInt16	-	Relay output control 0 = Open 1 = Closed (Note: This setting is effective only when the relay output control mode is manual control mode)
Relay Output State	202	R	1	UInt16	-	Relay output status 0 = open 1 = closed

6.7.4 Digital input

Register alias	Register initial address (decimal)	Operation read / write	Size	Type	Unit	Description
Relay output status	210	R	1	UInt16	-	0 = Open 1 = Closed

6.7.5 Voltage and current phase sequence:

Register alias	Register initial address (decimal)	Operation read / write	Size	Type	Unit	Description
Voltage current phase sequence state	220	R	1	UInt16	-	0 = voltage sequence is correct, current sequence is correct 1 = voltage sequence wrong, current sequence correct 2 = voltage sequence correct, current sequence wrong 3 = voltage sequence wrong, current sequence wrong

Note: Current phase sequence may be errors when the current is less than 1% of the nominal current

6.7.6 Configure instruction register

Register alias	Register initial address (decimal)	Operation Read / write	Size	Type	Unit	Description
Instruction code	300	R/W	1	UInt16	-	
Instruction parameters001	301	R/W	1	UInt16	-	
Instruction parameters002	302	R/W	1	UInt16	-	
...	...	R/W	1	UInt16	-	
Instruction parameters123	423	R/W	1	UInt16	-	
Configuration instruction code	424	R	1	UInt16	-	
Configuration results	425	R	1	UInt16	-	0 = valid operation 80 = invalid instruction code 81 = invalid instruction parameter 82 = number of invalid instruction parameters 83= operation not executed

6.7.7 Power system

Register alias	Register initial address (decimal)	Operation read / write	Size	Type	Unit	Description
Wiring mode	500	R/WC	1	UInt16	-	0=3P4W_4CT 1=3P4W_3CT 2=3P3W_3CT 3=3P3W_2CT 4=1P3W 5=1P2W
Grid frequency	501	R/WC	1	UInt16	Hz	
Nominal voltage	502	R/WC	1	UInt16	V	The VT ratio is not included
VT Ratio	503	R/WC	2	UInt32	-	Actual value = read value /10000
CT Ratio	505	R/WC	2	UInt32	-	Actual value = read value /10000
Phase L1L2L3 current transformer						

Register alias	Register initial address (decimal)	Operation read / write	Size	Type	Unit	Description
Phase L1L2L3 Sensor Type	510	R/WC	1	UInt16	-	0 = Rogowski coil 1 = VCT
Phase L1L2L3 Rogowski Coil Pri	511	R/WC	2	UInt32	A	
Phase L1L2L3 Rogowski Coil Sec	513	R/WC	2	UInt32	mV@50 Hz mV@60 Hz	Actual value = read value /100
Nominal current of Phase L1L2L3 Rogowski Coil	515	R/WC	2	UInt32	A	
Phase L1L2L3 VCT Pri	517	R/WC	2	UInt32	A	
Phase L1L2L3 VCT Sec	519	R/WC	2	UInt32	mV	Actual value = read value /100
Nominal current of Phase L1L2L3 VCT	521	R/WC	2	UInt32	A	
N-phase current transformer						
Phase N Sensor Type	530	R/WC	1	UInt16	-	0 = Rogowski coil 1 = VCT
Phase N Rogowski Coil Pri	531	R/WC	2	UInt32	A	
Phase N Rogowski Coil Sec	533	R/WC	2	UInt32	mV@50 Hz mV@60 Hz	Actual value = read value /100
Nominal current of Phase N Rogowski Coil	535	R/WC	2	UInt32	A	
Phase N VCT Pri	537	R/WC	2	UInt32	A	
Phase N VCT Sec	539	R/WC	2	UInt32	mV	Actual value = read value /100
Nominal current of Phase N VCT	541	R/WC	2	UInt32	A	

6.7.8 Zero drift suppression parameter

Register alias	Register initial address (decimal)	Operation read / write	Size	Type	Unit	Description
Voltage zero drift suppression	600	R/WC	1	UInt16	%	Voltage zero drift suppression Take (nominal voltage *VT ratio) as a reference Actual value = Read value /100
Current zero drift suppression	601	R/WC	1	UInt16	%	Current zero drift suppression Take (nominal current *CT ratio) as reference Actual value = Read value /100

6.7.9 Tariff parameter

Register alias	Register initial address (decimal)	Operation read / write	Size	Type	Unit	Description
Current Tariff	800	R	1	UInt16	-	Current Tariff 0-5= Tariff 1- Tariff 6
Tariff switching mode	801	R/WC	1	UInt16	-	Tariff switching mode 0=Manual 1=RTC
Manual Tariff selection	802	R/WC	1	UInt16	-	Manual Tariff selection 0-5= Tariff 1- Tariff 6
RTC Ta Start	803	R/WC	3	Time	-	RTC Ta Start
RTC Tb Start	806	R/WC	3	Time	-	RTC Tb Start
RTC Tc Start	809	R/WC	3	Time	-	RTC Tc Start
RTC Td Start	812	R/WC	3	Time	-	RTC Td Start
RTC Te Start	815	R/WC	3	Time	-	RTC Te Start
RTC Tf Start	818	R/WC	3	Time	-	RTC Tf Start
RTC Ta tariff select	821	R/WC	1	UInt16	-	Ta tariff select 0-5= Tariff 1- Tariff 6
RTC Tb tariff select	822	R/WC	1	UInt16	-	Tb tariff select 0-5= Tariff 1- Tariff 6
RTC Tc tariff select	823	R/WC	1	UInt16	-	Tc tariff select 0-5= Tariff 1- Tariff 6
RTC Td tariff select	824	R/WC	1	UInt16	-	Td tariff select 0-5= Tariff 1- Tariff 6
RTC Te tariff select	825	R/WC	1	UInt16	-	Te tariff select 0-5= Tariff 1- Tariff 6
RTC Tf tariff select	826	R/WC	1	UInt16	-	Tf tariff select 0-5= Tariff 1- Tariff 6

6.7.10 Voltage, current, power, power factor

Register alias	Register initial address (decimal)	Operation read / write	Size	Type	Unit	Description
Current						
I1	1000	R	2	Float32	A	Phase L1 current
I2	1002	R	2	Float32	A	Phase L2 current
I3	1004	R	2	Float32	A	Phase L3 current
Current Avg	1006	R	2	Float32	A	Average value of L1L2L3 three-phase current
IN	1008	R	2	Float32	A	Phase N current
Phase voltage						
U1	1010	R	2	Float32	V	U1-UN voltage
U2	1012	R	2	Float32	V	U2-UN voltage
U3	1014	R	2	Float32	V	U3-UN voltage
Phase Voltage Avg	1016	R	2	Float32	V	Average value of L1L2L3 three-phase phase voltage
U0	1018	R	2	Float32	V	zero sequence voltage
Line voltage						
U12	1020	R	2	Float32	V	U1-U2 voltage
U23	1022	R	2	Float32	V	U2-U3 voltage
U31	1024	R	2	Float32	V	U3-U1 voltage
Line Voltage Avg	1026	R	2	Float32	V	Average value of three-phase line voltage
Active power						
P1	1028	R	2	Float32	kW	Phase L1 Active power
P2	1030	R	2	Float32	kW	Phase L2 Active power
P3	1032	R	2	Float32	kW	Phase L3 Active power
PTotal	1034	R	2	Float32	kW	Total Active power
Reactive power						
Q1	1036	R	2	Float32	kVAR	Phase L1 Reactive power
Q2	1038	R	2	Float32	kVAR	Phase L2 Reactive power
Q3	1040	R	2	Float32	kVAR	Phase L3 Reactive power
QTotal	1042	R	2	Float32	kVAR	Total Reactive power
Apparent power						
S1	1044	R	2	Float32	kVA	Phase L1 Reactive power

Register alias	Register initial address (decimal)	Operation read / write	Size	Type	Unit	Description
S2	1046	R	2	Float32	kVA	Phase L2 Reactive power
S3	1048	R	2	Float32	kVA	Phase L3 Reactive power
STotal	1050	R	2	Float32	kVA	Total Reactive power
Power factor						
PF1	1052	R	2	Float32	-	Phase L1 Power factor
PF2	1054	R	2	Float32	-	Phase L2 Power factor
PF3	1056	R	2	Float32	-	Phase L3 Power factor
PFTotal	1058	R	2	Float32	-	Total Power factor
Fundamental harmonic power factor						
DPF1	1060	R	2	Float32	-	Phase L1 Fundamental harmonic power factor
DPF2	1062	R	2	Float32	-	Phase L2 Fundamental harmonic power factor
DPF3	1064	R	2	Float32	-	Phase L3 Fundamental harmonic power factor
DPFTotal	1066	R	2	Float32	-	Total Fundamental harmonic power factor
Frequency						
Freq1	1068	R	2	Float32	Hz	Phase L1 Frequency
Freq2	1070	R	2	Float32	Hz	Phase L2 Frequency
Freq3	1072	R	2	Float32	Hz	Phase L3 Frequency
FreqTotal	1074	R	2	Float32	Hz	Total Frequency

6.7.11 Energy

There are two types of energy, positive energy and reverse energy.

When the total electric energy reaches 1.0×10^9 kWh, 1.0×10^9 kvarh, or 1.0×10^9 KVAh, the electric energy of each phase will be cleared automatically.

Register alias	Register initial address (decimal)	Operation read / write	Size	Type	Unit	Description
Active Energy-Int64						
EP1Imp	2500	R	4	Int64	Wh	Phase L1 Positive active energy
EP2Imp	2504	R	4	Int64	Wh	Phase L2 Positive active energy
EP3Imp	2508	R	4	Int64	Wh	Phase L3 Positive active energy
EPImp	2512	R	4	Int64	Wh	Total Positive active energy

Register alias	Register initial address (decimal)	Operation read / write	Size	Type	Unit	Description
EP1Exp	2516	R	4	Int64	Wh	Phase L1 Reverse active energy
EP2Exp	2520	R	4	Int64	Wh	Phase L2 Reverse active energy
EP3Exp	2524	R	4	Int64	Wh	Phase L3 Reverse active energy
EPExp	2528	R	4	Int64	Wh	Total Reverse active energy
Reactive energy-Int64						
EQ1Imp	2532	R	4	Int64	VARh	Phase L1 Positive reactive energy
EQ2Imp	2536	R	4	Int64	VARh	Phase L2 Positive reactive energy
EQ3Imp	2540	R	4	Int64	VARh	Phase L3 Positive reactive energy
EQImp	2544	R	4	Int64	VARh	Total Positive reactive energy
EQ1Exp	2548	R	4	Int64	VARh	Phase L1 Reverse reactive energy
EQ2Exp	2552	R	4	Int64	VARh	Phase L2 Reverse reactive energy
EQ3Exp	2556	R	4	Int64	VARh	Phase L3 Reverse reactive energy
EQExp	2560	R	4	Int64	VARh	Total Reverse reactive energy
Apparent Energy-Int64						
ES1	2564	R	4	Int64	VAh	Phase L1 Apparent Energy
ES2	2568	R	4	Int64	VAh	Phase L2 Apparent Energy
ES3	2572	R	4	Int64	VAh	Phase L3 Apparent Energy
ES	2576	R	4	Int64	VAh	Total Apparent Energy
UInt32 Energy						
Active Energy- UInt32						
EP1Imp	2600	R	2	UInt32	kWh	Phase L1 Positive active energy
EP2Imp	2602	R	2	UInt32	kWh	Phase L2 Positive active energy
EP3Imp	2604	R	2	UInt32	kWh	Phase L3 Positive active energy
EPImp	2606	R	2	UInt32	kWh	Total Positive active energy
EP1Exp	2608	R	2	UInt32	kWh	Phase L1 Reverse active energy
EP2Exp	2610	R	2	UInt32	kWh	Phase L2 Reverse active energy
EP3Exp	2612	R	2	UInt32	kWh	Phase L3 Reverse active energy
EPExp	2614	R	2	UInt32	kWh	Total Reverse active energy
Reactive energy- UInt32						
EQ1Imp	2616	R	2	UInt32	kVARh	Phase L1 Positive reactive

Register alias	Register initial address (decimal)	Operation read / write	Size	Type	Unit	Description
						energy
EQ2Imp	2618	R	2	UInt32	kVARh	Phase L2 Positive reactive energy
EQ3Imp	2620	R	2	UInt32	kVARh	Phase L3 Positive reactive energy
EQImp	2622	R	2	UInt32	kVARh	Total Positive reactive energy
EQ1Exp	2624	R	2	UInt32	kVARh	Phase L1 Reverse reactive energy
EQ2Exp	2626	R	2	UInt32	kVARh	Phase L2 Reverse reactive energy
EQ3Exp	2628	R	2	UInt32	kVARh	Phase L3 Reverse reactive energy
EQExp	2630	R	2	UInt32	kVARh	Total Reverse reactive energy
Apparent Energy-UInt32						
ES1	2632	R	2	UInt32	kVAh	Phase L1 Apparent Energy
ES2	2634	R	2	UInt32	kVAh	Phase L2 Apparent Energy
ES3	2636	R	2	UInt32	kVAh	Phase L3 Apparent Energy
ES	2638	R	2	UInt32	kVAh	Total Apparent Energy

6.7.12 Tariff Energy

Tariff Energy types are Int64 and UInt32, whose unit size is different.

When the rate of electricity reaches 1.0×10^9 kWh, 1.0×10^9 kVarh, or 1.0×10^9 kVAh, each Tariff Energy will be automatically cleared to zero.

Register alias	Register initial address (decimal)	Operation read / write	Size	Type	Unit	Description
Tariff Energy-Int64						
ET1	2700	R	4	Int64	Wh	Tariff 1 Active Energy
ET2	2704	R	4	Int64	Wh	Tariff 2 Active Energy
ET3	2708	R	4	Int64	Wh	Tariff 3 Active Energy
ET4	2712	R	4	Int64	Wh	Tariff 4 Active Energy
ET5	2716	R	4	Int64	Wh	Tariff 5 Active Energy
ET6	2720	R	4	Int64	Wh	Tariff 6 Active Energy
Tariff Energy-UInt32						
ET1	2750	R	2	UInt32	kWh	Tariff 1 Active Energy
ET2	2752	R	2	UInt32	kWh	Tariff 2 Active Energy

Register alias	Register initial address (decimal)	Operation read / write	Size	Type	Unit	Description
ET3	2754	R	2	UInt32	kWh	Tariff 3 Active Energy
ET4	2756	R	2	UInt32	kWh	Tariff 4 Active Energy
ET5	2758	R	2	UInt32	kWh	Tariff 5 Active Energy
ET6	2760	R	2	UInt32	kWh	Tariff 6 Active Energy

6.7.13 Demand register

Register alias	Register initial address (decimal)	Operation read / write	Size	Type	Unit	Description
Basic parameters of demand						
DMDMethod	3000	R/WC	1	UInt16	-	Demand calculation method: 0= sliding type 1= fixed
DMD block	3001	R/RC	1	UInt16	Minute	Demand interval
PDMD Reset Time	3002	R	4	Date time	-	Peak demand reset date and time
Power demand						
P1Demand	3020	R	2	Float32	kW	Current active power demand of phase L1
P1PeakDemand	3022	R	2	Float32	kW	Peak demand of phase L1 active power
P1PeakDemand Date	3024	R	4	Date time	-	Occurrence time of peak demand of phase L1 active power
P2Demand	3028	R	2	Float32	kW	Current active power demand of phase 2
P2PeakDemand	3030	R	2	Float32	kW	Peak demand of phase 2 active power
P2PeakDemand Date	3032	R	4	Date time	-	Occurrence time of peak demand of phase 2 active power
P3Demand	3036	R	2	Float32	kW	Current active power demand of phase 3
P3PeakDemand	3038	R	2	Float32	kW	Peak demand of phase 3 active power
P3PeakDemand Date	3040	R	4	Date time	-	Occurrence time of peak demand of phase 3 active power
PSUMDemand	3044	R	2	Float32	kW	Current total active power demand

Register alias	Register initial address (decimal)	Operation read / write	Size	Type	Unit	Description
PSUMPeakDemand	3046	R	2	Float32	kW	Peak demand of total active power
PSUMPeakDemandDate	3048	R	4	Date time	-	Occurrence time of peak demand of total active power
Q1Demand	3052	R	2	Float32	kVar	Current reactive power demand of phase L1
Q1PeakDemand	3054	R	2	Float32	kVar	Peak demand of phase L1 reactive power
Q1PeakDemandDate	3056	R	4	Date time	-	Occurrence time of peak demand of phase L1 reactive power
Q2Demand	3060	R	2	Float32	kVar	Current reactive power demand of phase L2
Q2PeakDemand	3062	R	2	Float32	kVar	Peak demand of phase L2 reactive power
Q2PeakDemandDate	3064	R	4	Date time	-	Occurrence time of peak demand of phase L2 reactive power
Q3Demand	3068	R	2	Float32	kVar	Current reactive power demand of phase L3
Q3PeakDemand	3070	R	2	Float32	kVar	Peak demand of phase L3 reactive power
Q3PeakDemandDate	3072	R	4	Date time	-	Occurrence time of peak demand of phase L3 reactive power
QSUMDemand	3076	R	2	Float32	kVar	Current total reactive power demand
QSUMPeakDemand	3078	R	2	Float32	kVar	Peak demand of total reactive power
QSUMPeakDemandDate	3080	R	4	Date time	-	Occurrence time of peak demand of total reactive power
S1Demand	3084	R	2	Float32	kVa	Current apparent power demand of phase L1
S1PeakDemand	3086	R	2	Float32	kVa	Peak demand of phase L1 apparent power
S1PeakDemandDate	3088	R	4	Date time	-	Occurrence time of peak demand of phase L1 apparent power
S2Demand	3092	R	2	Float32	kVa	Current apparent power demand of phase L2
S2PeakDemand	3094	R	2	Float32	kVa	Peak demand of phase L2 apparent power
S2PeakDemandDate	3096	R	4	Date time	-	Occurrence time of peak demand of phase L2 apparent power

Register alias	Register initial address (decimal)	Operation read / write	Size	Type	Unit	Description
S3Demand	3100	R	2	Float32	kVa	Current apparent power demand of phase L3
S3PeakDemand	3102	R	2	Float32	kVa	Peak demand of phase L3 apparent power
S3PeakDemand Date	3104	R	4	Date time	-	Occurrence time of peak demand of phase L3 apparent power
SSUMDemand	3108	R	2	Float32	kVa	Current total apparent power demand
SSUMPeakDemand	3110	R	2	Float32	kVa	Peak demand of total apparent power
SSUMPeakDemandDate	3112	R	4	Date time	-	Occurrence time of peak demand of total apparent power

6.7.14 Voltage and current harmonic register

Register name	Register initial address (decimal)	Operation	Size	Type	Unit	Description
Current harmonic percentage						
I1THD	4000	R	2	Float32	%	Phase L1 current total harmonic percentage
I2THD	4002	R	2	Float32	%	Phase L2 current total harmonic percentage
I3THD	4004	R	2	Float32	%	Phase L3 current total harmonic percentage
I1TOHD	4006	R	2	Float32	%	Phase L1 current odd total harmonic percentage
I2TOHD	4008	R	2	Float32	%	Phase L2 current odd total harmonic percentage
I3TOHD	4010	R	2	Float32	%	Phase L3 current odd total harmonic percentage
I1TEHD	4012	R	2	Float32	%	Phase L1 current even total harmonic percentage
I2TEHD	4014	R	2	Float32	%	Phase L2 current even total harmonic percentage
I3TEHD	4016	R	2	Float32	%	Phase L3 current even total harmonic percentage
I1HD1	4018	R	2	Float32	%	1st harmonic percentage of phase L1 current
I2HD1	4020	R	2	Float32	%	1st harmonic percentage of phase L2 current

Register name	Register initial address (decimal)	Operation	Size	Type	Unit	Description
I3HD1	4022	R	2	Float32	%	1st harmonic percentage of phase L3 current
...	4024-4311	The 2nd-49th harmonic percentage of L1L2L3 phase current
I1HD50	4312	R	2	Float32	%	The 50th harmonic percentage of phase L1 current
I2HD50	4314	R	2	Float32	%	The 50th harmonic percentage of phase L2 current
I3HD50	4316	R	2	Float32	%	The 50th harmonic percentage of phase L3 current
Current harmonic value						
I1HDV1	4400	R	2	Float32	A	Fundamental current value of phase L1 current
I2HDV1	4402	R	2	Float32	A	Fundamental current value of phase L2 current
I3HDV1	4404	R	2	Float32	A	Fundamental current value of phase L3 current
...	4406-4693	The 2nd-49th harmonic current value of L1L2L3 phase current
I1HDV50	4694	R	2	Float32	A	The 50th harmonic current value of phase L1 current
I2HDV50	4696	R	2	Float32	A	The 50th harmonic current value of phase L2 current
I3HDV50	4698	R	2	Float32	A	The 50th harmonic current value of phase L3 current
Voltage harmonic percentage						
U1THD	5000	R	2	Float32	%	Phase L1 voltage total harmonic percentage
U2THD	5002	R	2	Float32	%	Phase L2 voltage total harmonic percentage
U3THD	5004	R	2	Float32	%	Phase L3 voltage total harmonic percentage
U1TOHD	5006	R	2	Float32	%	Phase L1 voltage odd total harmonic percentage
U2TOHD	5008	R	2	Float32	%	Phase L2 voltage odd total harmonic percentage
U3TOHD	5010	R	2	Float32	%	Phase L3 voltage odd total harmonic percentage
U1TEHD	5012	R	2	Float32	%	Phase L1 voltage even total harmonic percentage
U2TEHD	5014	R	2	Float32	%	Phase L2 voltage even total harmonic percentage

Register name	Register initial address (decimal)	Operation	Size	Type	Unit	Description
U3TEHD	5016	R	2	Float32	%	Phase L3 voltage even total harmonic percentage
U1HD1	5018	R	2	Float32	%	The 1st harmonic percentage of phase L1 voltage
U2HD1	5020	R	2	Float32	%	The 1st harmonic percentage of phase L2 voltage
U3HD1	5022	R	2	Float32	%	The 1st harmonic percentage of phase L3 voltage
...	5024-5311	The 2nd-49th harmonic percentage of L1L2L3 phase voltage
U1HD50	5312	R	2	Float32	%	The 50th harmonic percentage of phase L1 voltage
U2HD50	5314	R	2	Float32	%	The 50th harmonic percentage of phase L2 voltage
U3HD50	5316	R	2	Float32	%	The 50th harmonic percentage of phase L3 voltage
Voltage harmonic value						
U1HDV1	5400	R	2	Float32	V	The 1st harmonic voltage value of phase L1 voltage
U2HDV1	5402	R	2	Float32	V	The 1st harmonic voltage value of phase L2 voltage
U3HDV1	5404	R	2	Float32	V	The 1st harmonic voltage value of phase L3 voltage
...	5406-5693	The 2nd-49th harmonic voltage value of L1L2L3 phase voltage
U1HDV50	5694	R	2	Float32	V	The 50th harmonic voltage value of phase L1 voltage
U2HDV50	5696	R	2	Float32	V	The 50th harmonic voltage value of phase L2 voltage
U3HDV50	5698	R	2	Float32	V	The 50th harmonic voltage value of phase L3 voltage

6.7.15 Max.&Min.

Register name	Register initial address (decimal)	Operation	Size	Type	Unit	Description
Current max / min						
I1Max	6000	R	2	Float32	A	Phase L1 Maximum current
I2Max	6002	R	2	Float32	A	Phase L2 Maximum current
I3Max	6004	R	2	Float32	A	Phase L3 Maximum current

I1VGMMax	6006	R	2	Float32	A	Maximum three phase average current
IN Max	6008	R	2	Float32	A	Phase N Maximum current
I1Min	6010	R	2	Float32	A	Phase L1 Minimum current
I2Min	6012	R	2	Float32	A	Phase L2 Minimum current
I3Min	6014	R	2	Float32	A	Phase L3 Minimum current
I1VGMin	6016	R	2	Float32	A	Minimum three phase average current
IN Min	6018	R	2	Float32	A	Phase N Minimum current
Voltage max / min						
U1Max	6020	R	2	Float32	V	U1-UN Maximum phase voltage
U2Max	6022	R	2	Float32	V	U2-UN Maximum phase voltage
U3Max	6024	R	2	Float32	V	U3-UN Maximum phase voltage
Phase UAVGMax	6026	R	2	Float32	V	Maximum value of average value of three-phase phase voltage.
U1Min	6030	R	2	Float32	V	U1-UN Minimum phase voltage
U2Min	6032	R	2	Float32	V	U2-UN Minimum phase voltage
U3Min	6034	R	2	Float32	V	U3-UN Minimum phase voltage
U1VGMin	6036	R	2	Float32	V	Minimum value of average value of three-phase phase voltage.
U12Max	6040	R	2	Float32	V	U1-U2 Maximum wire voltage
U23Max	6042	R	2	Float32	V	U2-U3 Maximum wire voltage
U31Max	6044	R	2	Float32	V	U3-U1 Maximum wire voltage
LineUAVGMax	6046	R	2	Float32	V	Maximum value of average value of three-phase phase voltage.
U12Min	6050	R	2	Float32	V	U1-U2 Minimum phase voltage
U23Min	6052	R	2	Float32	V	U2SS-U3 Minimum phase voltage
U31Min	6054	R	2	Float32	V	U3-U1 Minimum phase voltage
LineUAVGMin	6056	R	2	Float32	V	Minimum value of average value of three-phase phase voltage.
Maximum / minimum power						
P1Max	6060	R	2	Float32	kW	Maximum active power of phase L1
P2Max	6062	R	2	Float32	kW	Maximum active power of phase L2
P3Max	6064	R	2	Float32	kW	Maximum active power of phase L3
PSUMMax	6066	R	2	Float32	kW	Maximum value of three-phase total active power
P1Min	6070	R	2	Float32	kW	Minimum active power of phase L1
P2Min	6072	R	2	Float32	kW	Minimum active power of phase L2
P3Min	6074	R	2	Float32	kW	Minimum active power of phase L3
PSUMMin	6076	R	2	Float32	kW	Minimum value of three-phase total active power
Reactive Power Max / min						
Q1Max	6080	R	2	Float32	kVar	Maximum value of phase L1 reactive power

Q2Max	6082	R	2	Float32	kVar	Maximum value of phase L2 reactive power
Q3Max	6084	R	2	Float32	kVar	Maximum value of phase L3 reactive power
QSUMMax	6086	R	2	Float32	kVar	Maximum value of three-phase total reactive power
Q1Min	6090	R	2	Float32	kVar	Minimum value of phase L1 reactive power
Q2Min	6092	R	2	Float32	kVar	Minimum value of phase L2 reactive power
Q3Min	6094	R	2	Float32	kVar	Minimum value of phase L3 reactive power
QSUMMin	6096	R	2	Float32	kVar	Minimum value of three-phase total reactive power
Apparent power max / min						
S1Max	6100	R	2	Float32	kVa	Maximum apparent power of phase L1
S2Max	6102	R	2	Float32	kVa	Maximum apparent power of phase L2
S3Max	6104	R	2	Float32	kVa	Maximum apparent power of phase L3
SSUMMax	6106	R	2	Float32	kVa	Maximum three-phase total apparent power
S1Min	6110	R	2	Float32	kVa	Minimum apparent power of phase L1
S2Min	6112	R	2	Float32	kVa	Minimum apparent power of phase L2
S3Min	6114	R	2	Float32	kVa	Minimum apparent power of phase L3
SSUMMin	6116	R	2	Float32	kVa	Minimum three phase total apparent power

6.7.16 Unbalance

Register name	Register initial address (decimal)	Operation	Size	Type	Unit	Description
Current negative sequence unbalance	7000	R	2	Float32	%	Current negative sequence unbalance
Current zero sequence unbalance	7002	R	2	Float32	%	Current zero sequence unbalance
Voltage negative sequence unbalance	7004	R	2	Float32	%	Voltage negative sequence unbalance
Voltage zero sequence unbalance	7006	R	2	Float32	%	Voltage zero sequence unbalance

6.7.17 Current K-factor and crest factor register

Register name	Register initial address (decimal)	Operation	Size	Type	Unit	Description
Current K factor						
KFI1	8000	R	2	Float32	-	Current K factor of phase L1
KFI2	8002	R	2	Float32	-	Current K factor of phase L2
KFI3	8004	R	2	Float32	-	Current K factor of phase L3

6.7.18 Voltage and current angle register

Register name	Register initial address (decimal)	Operation	Size	Type	Unit	Description
Angle voltages:						
U1	8100	R	2	Float32	°	Angle phase L1 voltage
U2	8102	R	2	Float32	°	Angle phase L2 voltage
U3	8104	R	2	Float32	°	Angle phase L3 voltage
Angle currents:						
I1	8106	R	2	Float32	°	Angle phase L1 current
I2	8108	R	2	Float32	°	Angle phase L2 current
I3	8110	R	2	Float32	°	Angle phase L3 current
Angle between voltage and current:						
UI1	8112	R	2	Float32	°	Angle between voltage and current of phase L1
UI2	8114	R	2	Float32	°	Angle between voltage and current of phase L2
UI3	8116	R	2	Float32	°	Angle between voltage and current of phase L3

6.7.19 Alarm

Register name	Register initial address (decimal)	Operation	Size	Type	Unit	Description
Alarm map						
Enabled alarm bitmap						
Enabled alarm	10000	R	1	bitmap	-	0=Alarm disabled

Register name	Register initial address (decimal)	Operation	Size	Type	Unit	Description
bitmap1						1=Alarm enabled Bit N(0-15)=Alarm ID N(1-16)
Enabled alarm bitmap2	10001	R	1	bitmap	-	0=Alarm disabled 1=Alarm enabled Bit N(0-15)=Alarm ID N(17-32)
Actiactive alarm bit map						
Actiactive alarm bit map 1	10010	R	1	bitmap	-	0=Alarm not activated 1=Alarm activation Bit N(0-15)=Alarm ID N(1-16)
Actiactive alarm bit map 2	10011	R	1	bitmap	-	0=Alarm not activated 1=Alarm activation Bit N(0-15)=Alarm ID N(17-32)
Current alarm output bitmap						
(Note: Up to 1 alarm output at the same time)						
Current alarm output bitmap 1	10020	R	1	bitmap	-	0=Alarm not output 1=Alarm output Bit N(0-15)=Alarm ID N(1-16)
Current alarm output bitmap 2	10021	R	1	bitmap	-	0=Alarm not output 1=Alarm output Bit N(0-15)=Alarm ID N(17-32)
Alarm parameters						
Current Over , each phase						Alarm ID=1
(Note: One phase above the activation threshold produces an alarm, all phases below the alarm release point, alarm release)						
Alarm Status	10100	R/WC	1	UInt16	-	Alarm Status 0=Disable 1=Enable
Alarm activation threshold	10102	R/WC	2	Float32	A	Alarm activation threshold

Register name	Register initial address (decimal)	Operation	Size	Type	Unit	Description
Alarm release point	10104	R/WC	2	Float32	%	Percentage error of alarm release point relative to alarm activation threshold Example: over current alarm activation threshold =100A alarm release point =5%. When the current value is less than $100-100*5\%=95A$, the alarm will be released
Buzzer	10106	R/WC	1	UInt16	-	Buzzer 0=Unlinked 1=Linked
Relay	10107	R/WC	1	UInt16	-	Relay 0=Unlinked 1=Linked (Note: Control is valid only valid if the relay output mode is alarm output mode)
Current Under, each phase					Alarm ID=2	
Alarm Status	10120	R/WC	1	UInt16	-	Alarm Status 0=Disable 1=Enable
Alarm activation threshold	10122	R/WC	2	Float32	A	Alarm activation threshold
Alarm release point	10124	R/WC	2	Float32	%	Percentage error of alarm release point relative to alarm activation threshold
Buzzer	10126	R/WC	1	UInt16	-	Buzzer 0=Unlinked 1=Linked
Relay	10127	R/WC	1	UInt16	-	Relay 0=Unlinked 1=Linked
Phase Voltage Over, L-N					Alarm ID=3	
Alarm Status	10140	R/WC	1	UInt16	-	Alarm Status 0=Disable 1=Enable
Alarm activation threshold	10142	R/WC	2	Float32	V	Alarm activation threshold
Alarm release point	10144	R/WC	2	Float32	%	Percentage error of alarm release point relative to alarm activation threshold

Register name	Register initial address (decimal)	Operation	Size	Type	Unit	Description
Buzzer	10146	R/WC	1	UInt16	-	Buzzer 0=Unlinked 1=Linked
Relay	10147	R/WC	1	UInt16	-	Relay 0=Unlinked 1=Linked
Phase Voltage Under, L-N						Alarm ID=4
Alarm Status	10160	R/WC	1	UInt16	-	Alarm Status 0=Disable 1=Enable
Alarm activation threshold	10162	R/WC	2	Float32	V	Alarm activation threshold
Alarm release point	10164	R/WC	2	Float32	%	Percentage error of alarm release point relative to alarm activation threshold
Buzzer	10166	R/WC	1	UInt16	-	Buzzer 0=Unlinked 1=Linked
Relay	10167	R/WC	1	UInt16	-	Relay 0=Unlinked 1=Linked
Line Voltage Over, L-L						Alarm ID=5
Alarm Status	10180	R/WC	1	UInt16	-	Alarm Status 0=Disable 1=Enable
Alarm activation threshold	10182	R/WC	2	Float32	V	Alarm activation threshold
Alarm release point	10184	R/WC	2	Float32	%	Percentage error of alarm release point relative to alarm activation threshold
Buzzer	10186	R/WC	1	UInt16	-	Buzzer 0=Unlinked 1=Linked
Relay	10187	R/WC	1	UInt16	-	Relay 0=Unlinked 1=Linked
Line Voltage Under, L-L						Alarm ID=6
Alarm Status	10200	R/WC	1	UInt16	-	Alarm Status 0=Disable

Register name	Register initial address (decimal)	Operation	Size	Type	Unit	Description
						1=Enable
Alarm activation threshold	10202	R/WC	2	Float32	V	Alarm activation threshold
Alarm release point	10204	R/WC	2	Float32	%	Percentage error of alarm release point relative to alarm activation threshold
Buzzer	10206	R/WC	1	UInt16	-	Buzzer 0=Unlinked 1=Linked
Relay	10207	R/WC	1	UInt16	-	Relay 0=Unlinked 1=Linked
Power P Over, (absolute value)						Alarm ID=10
Alarm Status	10220	R/WC	1	UInt16	-	Alarm Status 0=Disable 1=Enable
Alarm activation threshold	10222	R/WC	2	Float32	kW	Alarm activation threshold
Alarm release point	10224	R/WC	2	Float32	%	Percentage error of alarm release point relative to alarm activation threshold
Buzzer	10226	R/WC	1	UInt16	-	Buzzer 0=Unlinked 1=Linked
Relay	10227	R/WC	1	UInt16	-	Relay 0=Unlinked 1=Linked
Power Q Over, (absolute value)						Alarm ID=14
Alarm Status	10240	R/WC	1	UInt16	-	Alarm Status 0=Disable 1=Enable
Alarm activation threshold	10242	R/WC	2	Float32	kVar	Alarm activation threshold
Alarm release point	10244	R/WC	2	Float32	%	Percentage error of alarm release point relative to alarm activation threshold
Buzzer	10246	R/WC	1	UInt16	-	Buzzer 0=Unlinked 1=Linked

Register name	Register initial address (decimal)	Operation	Size	Type	Unit	Description
Relay	10247	R/WC	1	UInt16	-	Relay 0=Unlinked 1=Linked
Power S Over						Alarm ID=18
Alarm Status	10260	R/WC	1	UInt16	-	Alarm Status 0=Disable 1=Enable
Alarm activation threshold	10262	R/WC	2	Float32	kVA	Alarm activation threshold
Alarm release point	10264	R/WC	2	Float32	%	Percentage error of alarm release point relative to alarm activation threshold
Buzzer	10266	R/WC	1	UInt16	-	Buzzer 0=Unlinked 1=Linked
Relay	10267	R/WC	1	UInt16	-	Relay 0=Unlinked 1=Linked
Power P DMD Over, (current)						Alarm ID=20
Alarm Status	10280	R/WC	1	UInt16	-	Alarm Status 0=Disable 1=Enable
Alarm activation threshold	10282	R/WC	2	Float32	kW	Alarm activation threshold
Alarm release point	10284	R/WC	2	Float32	%	Percentage error of alarm release point relative to alarm activation threshold
Buzzer	10286	R/WC	1	UInt16	-	Buzzer 0=Unlinked 1=Linked
Relay	10287	R/WC	1	UInt16	-	Relay 0=Unlinked 1=Linked
Power Q DMD Over, (absolute value) (current)						Alarm ID=21
Alarm Status	10300	R/WC	1	UInt16	-	Alarm Status 0=Disable 1=Enable
Alarm activation	10302	R/WC	2	Float32	kVar	Alarm activation threshold

Register name	Register initial address (decimal)	Operation	Size	Type	Unit	Description
threshold						
Alarm release point	10304	R/WC	2	Float32	%	Percentage error of alarm release point relative to alarm activation threshold
Buzzer	10306	R/WC	1	UInt16	-	Buzzer 0=Unlinked 1=Linked
Relay	10307	R/WC	1	UInt16	-	Relay 0=Unlinked 1=Linked
Power S DMD Over, (current)						Alarm ID=22
Alarm Status	10320	R/WC	1	UInt16	-	Alarm Status 0=Disable 1=Enable
Alarm activation threshold	10322	R/WC	2	Float32	kVA	Alarm activation threshold
Alarm release point	10324	R/WC	2	Float32	%	Percentage error of alarm release point relative to alarm activation threshold
Buzzer	10326	R/WC	1	UInt16	-	Buzzer 0=Unlinked 1=Linked
Relay	10327	R/WC	1	UInt16	-	Relay 0=Unlinked 1=Linked
THD-U Over, each phase						Alarm ID=30
Alarm Status	10340	R/WC	1	UInt16	-	Alarm Status 0=Disable 1=Enable
Alarm activation threshold	10342	R/WC	2	Float32	%	Alarm activation threshold
Alarm release point	10344	R/WC	2	Float32	%	Percentage error of alarm release point relative to alarm activation threshold
Buzzer	10346	R/WC	1	UInt16	-	Buzzer 0=Unlinked 1=Linked
Relay	10347	R/WC	1	UInt16	-	Relay 0=Unlinked 1=Linked

Register name	Register initial address (decimal)	Operation	Size	Type	Unit	Description
THD-I Over, each phase						Alarm ID=31
Alarm Status	10360	R/WC	1	UInt16	-	Alarm Status 0=Disable 1=Enable
Alarm activation threshold	10362	R/WC	2	Float32	%	Alarm activation threshold
Alarm release point	10364	R/WC	2	Float32	%	Percentage error of alarm release point relative to alarm activation threshold
Buzzer	10366	R/WC	1	UInt16	-	Buzzer 0=Unlinked 1=Linked
Relay	10367	R/WC	1	UInt16	-	Relay 0=Unlinked 1=Linked

7 Revision History

Version	Date	Change	By
V1.0	2022/12/09	Create document	Walter
V1.1	2024/06/20	Add Modbus communication Corrected the issue of voltage and current unbalance, Modbus register definition error	Walter
V1.3	2024/11/04	1. Corrected the error of VT and CT ratio formulas.	Walter
V1.4	2025/02/24	1. Correct the wording errors in the selection table.	Ming